



**ADAMERA**  
MINERALS

**SAFETY MANUAL/FIELD GUIDE**

## **TABLE OF CONTENTS**

### **INTRODUCTION**

**SECTION A CAMP REGULATIONS**

**SECTION B PERSONAL SUPPLY LIST**

**SECTION C SAFETY ON EXPLORATION PROJECTS**

**SECTION D EMERGENCY PROCEDURES**

**SECTION E FIRE PROCEDURES**

**SECTION F MEDICAL/MEDIVAC PROCEDURES**

**SECTION G HEAD OFFICE ADDRESS**

# TABLE OF CONTENTS

<b>INTRODUCTION.....</b>	<b>2</b>
<b>SECTION A.....</b>	<b>3</b>
<b>1. CAMP REGULATIONS.....</b>	<b>3</b>
<b>1.1. CAMP MEALS.....</b>	<b>3</b>
<b>1.2. SOCIALIZING.....</b>	<b>3</b>
<b>1.3. WORK CATEGORY .....</b>	<b>3</b>
<b>1.4. ENVIRONMENT RULES .....</b>	<b>3</b>
<b>1.5. CAMP COMMUNICATIONS.....</b>	<b>4</b>
<b>1.6. SMOKING .....</b>	<b>4</b>
<b>1.7. MISCELLANEOUS .....</b>	<b>5</b>
<b>SECTION B.....</b>	<b>6</b>
<b>2. PERSONAL SUPPLIES .....</b>	<b>6</b>
<b>SECTION C.....</b>	<b>7</b>
<b>3. SAFETY ON EXPLORATION PROJECTS.....</b>	<b>7</b>
<b>3.1 SAFETY EQUIPMENT .....</b>	<b>7</b>
<b>3.1.1 CAMP.....</b>	<b>7</b>
<b>3.1.2 FIELD .....</b>	<b>7</b>
<b>3.1.3 SURVIVAL GEAR.....</b>	<b>7</b>
<b>3.2 AIRCRAFT SAFETY.....</b>	<b>8</b>
<b>3.2.1 SAFE OPERATING PROCEDURES FOR HELICOPTERS.....</b>	<b>9</b>
<b>3.2.2 ADDITIONAL SAFETY PROCEDURES FOR HELICOPTERS .....</b>	<b>10</b>
<b>3.2.3 REGARDING THE MACHINE, THE PILOT MUST BE OBEYED AT ALL TIMES .</b>	<b>11</b>

<b>4.</b>	<b>WATER SAFETY</b> .....	<b>11</b>
<b>4.1</b>	<b>USE OF LIFEJACKETS</b> .....	<b>11</b>
<b>5.</b>	<b>WINTER SAFETY</b> .....	<b>12</b>
<b>6.</b>	<b>SNOWMOBILE SAFETY</b> .....	<b>12</b>
<b>7.</b>	<b>ILLNESS LINKED TO COLD, HEAT AND ALTITUDE</b> .....	<b>12</b>
<b>7.1.1</b>	<b>HYPOTHERMIA</b> .....	<b>13</b>
<b>7.1.2</b>	<b>COLD WATER IMMERSION HYPOTHERMIA</b> .....	<b>16</b>
<b>7.1.3</b>	<b>FROSTBITE</b> .....	<b>17</b>
<b>7.1.4</b>	<b>WIND CHILL CHARTS</b> .....	<b>19</b>
<b>8.</b>	<b>CAMP CLEANLINESS</b> .....	<b>21</b>
<b>9.</b>	<b>FUEL HANDLING</b> .....	<b>22</b>
<b>10.</b>	<b>TENT MAINTENANCE</b> .....	<b>23</b>
<b>11.</b>	<b>MECHANICAL EQUIPMENT</b> .....	<b>24</b>
<b>12.</b>	<b>HEATERS AND LANTERNS</b> .....	<b>24</b>
<b>13.</b>	<b>SURVIVAL</b> .....	<b>28</b>
<b>13.1</b>	<b>HOW TO PREVENT A SURVIVAL SITUATION</b> .....	<b>29</b>
<b>13.1.1</b>	<b>Preparation to Prevent Survival Situations</b> .....	<b>29</b>
<b>13.1.2</b>	<b>Routines to Prevent Survival Situations</b> .....	<b>29</b>
<b>13.2</b>	<b>PREPARATION TO CONFRONT A SURVIVAL SITUATION</b> .....	<b>31</b>
<b>13.3</b>	<b>SURVIVAL EQUIPMENT LISTS</b> .....	<b>33</b>
<b>13.4</b>	<b>GENERAL ADVICE FOR SURVIVAL SITUATIONS</b> .....	<b>34</b>
<b>13.4.1</b>	<b>Survival Advice for Cold Climate Conditions</b> .....	<b>35</b>
<b>13.5</b>	<b>PRIORITIES IN A SURVIVAL SITUATION</b> .....	<b>36</b>
<b>13.5.1</b>	<b>First Aid</b> .....	<b>36</b>
<b>13.5.2</b>	<b>Location</b> .....	<b>36</b>

13.5.3	Shelter .....	36
13.5.4	Fire .....	40
13.5.5	Water and Food .....	41
13.5.6	Signalling.....	43
13.6	IMPROVISATION AS A SURVIVAL STRATEGY .....	45
	<b>EMERGENCY RESPONSE PROCEDURES FOR SURVIVAL .....</b>	<b>47</b>
14.	<b>DRILL SITE PROTOCOL.....</b>	<b>48</b>
15.	<b>DRILLING .....</b>	<b>49</b>
15.1	RESPONSIBILITIES .....	50
15.2	DRILL SITE LOCATION, PLANNING AND PREPARATION.....	50
15.3	ESSENTIAL SAFETY PROCEDURES .....	51
15.3.1	Emergency Response Plans (ERPs).....	51
15.3.2	Communications .....	51
15.3.3.	Pre-program Safety Meeting.....	51
15.3.4.	Accident Reporting.....	52
15.3.5	Safety Inspections .....	52
15.3.6	Personnel Conduct.....	52
15.4	OPERATIONAL SAFETY .....	53
15.4.1	General Safety Issues .....	53
15.4.2	Personal Protective Equipment (PPE) .....	54
15.4.3	Housekeeping.....	55
15.4.4	Manual Handling.....	55
15.5	COMMON TYPES OF DRILLING INJURIES .....	56
15.6	HAZARDS LINKED WITH SPECIFIC EQUIPMENT .....	57

15.6.1	Pressure Hazards.....	57
15.6.1.1	Compressed Air Systems .....	57
15.6.1.2	Hydraulic Systems .....	59
15.6.1.3	High Pressure Pumping Systems .....	59
15.6.2	Mechanical Hazards .....	59
15.6.2.1	Rotating Drill Rods.....	60
15.6.2.2	Exposed Machine Parts .....	60
15.6.2.3	Entanglement (“Pinch Points” or “Nip Points”) .....	60
15.6.2.4	Mechanical Failures.....	60
15.7	Hazardous Substances .....	61
15.7.1	Dust .....	61
15.7.2	Other Hazardous Substances .....	61
15.8	FIRE.....	61
15.9	HEALTH.....	62
15.9.1	Noise.....	62
15.9.2	General Health Issues .....	62
<b>SECTION D.....</b>		<b>63</b>
<b>EMERGENCY PROCEDURES.....</b>		<b>63</b>
<b>SECTION E.....</b>		<b>65</b>
<b>FIRE PROCEDURES .....</b>		<b>65</b>
<b>SECTION F .....</b>		<b>66</b>
<b>MEDICAL/MEDIVAC PROCEDURES.....</b>		<b>66</b>
<b>SECTION G .....</b>		<b>67</b>
<b>HEAD OFFICE ADDRESS .....</b>		<b>67</b>

# FIELD GUIDE

## INTRODUCTION

This guide has been assembled for the information of all personnel engaged in Adamera Mineral's numerous field activities. It is required reading for those who are going into the field for the first time. It applies equally to those returning for the n'th time.

During the field season, a small number of people with different personalities and experience have to live closely together. The more aware each individual is of the problems of living under relatively hard and remote conditions and how to keep things running smoothly, the better will be the spirit of the whole camp, the work better done and the field season more enjoyable.

The intention of these notes is to draw attention to a variety of common sense problems which can all too often produce ill feeling or cause accidents in a camp environment. In addition, company and camp regulations will be summarized.

The overriding consideration in our field program is safety. We could be working under extreme climatic conditions in remote areas a considerable distance away from medical services. Use common sense to prevent most accidents and to treat injuries until help arrives. **Everyone must be constantly aware of safety.** So please read this manual carefully.

Apart from the day's exploration work, there are basic chores which have to be done related simply to day-to-day life. The most enjoyable camps are those in which everyone participates in every aspect of camp life. No one should have to be asked to do something. Everyone should keep an eye open for the things that need doing. This has the effect of making things run very efficiently and generating more time for relaxation.

Please take the following notes seriously, even if some topics seem ridiculous.

## SECTION A

### 1. CAMP REGULATIONS

#### 1.1. CAMP MEALS

Meal times in the camp are largely governed by the dominant activity. Adjustments to this schedule dependent on field activities. Note: all personnel are responsible for starting their day as designated. e.g. Dominant activity drilling.

Breakfast	-Driller (day shift)	-6:00 AM to 6:30 AM
	-Major Staff	-6:30 AM to 7:30 AM
	-Drillers (night shift)	-7:30 AM to 8:30 AM
Lunch (in camp)	-12:00 noon to 1:00 P.M.	
Dinner	-Driller (day shift)	-5:30 PM TO 6:00 PM
	-Major Staff	-6:00 PM to 6:45 PM
	-Driller (night shift)	-8:00 PM to 8:30 PM

These times are subject to change. Please note that **THERE IS NO SMOKING IN THE KITCHEN OR EATING AREA**. The cook shack is the domain for our cooking staff. Making their job easier will bring innumerable benefits.

#### 1.2. SOCIALIZING

Socializing is up to the individual employee's discretion. However, work of the day must be completed and the next day's preparations must be made before considering such. As our camps are small isolated, communities, employee socializing must take this into consideration.

Adamera camps are officially dry camps. **NO ALCOHOLIC BEVERAGES OR DRUGS** may be brought into or ordered into the camp during the field season.

#### 1.3. WORK CATEGORY

As we are in an isolated camp, many duties of general living (i.e., building, repairing, clean-ups, etc.) are not always the domain of any one person. Everyone will be involved in maintaining and constructing the camp. Each Saturday, one person will be in camp to help with the food order. This person will also be responsible for cleaning the dry, shower and shitters.

#### 1.4. ENVIRONMENT RULES

Present day society demands consideration of the environment. It is extremely important that we set and maintain high environmental standards. Our performance is monitored by Territorial government agencies, by representatives of native organizations and communities and by our peers. We require approval from many of these bodies. The following regulations will be strictly enforced.

- a) No unnecessary destruction of vegetation or wildlife. No harassment of wildlife.



- b) No pollution of the campsites or work area – if you spend the day in the field, clean up your lunch garbage and return it for camp disposal. All campsites must be kept immaculately clean. Land use inspectors can inspect campsite at any time. They have the power to suspend operations if their standards are not met. Be very careful transferring fuel from drums to fuel tanks, skidoos, all-terrain vehicles etc. to minimize fuel spillage. If you notice any leaking drums or cylinders around the camp, let the project manager or the camp manager know immediately!
- c) Be careful with fire – all camp fires should be extinguished completely, all cigarettes put out in wet ground or on bare rock. Various containers will be provided around camp for the disposal of cigarette butts.
- d) Fishing licenses are required in most areas of Canada. Purchase one before you arrive in camp. Responsible fishing is encouraged – keep what you catch and eat what you catch. The local fish can be returned to the water if simple lures (i.e., flies, barbless) are used and minimal damage is done on catching.
- e) No unauthorized fire arms are allowed in an Adamera camp. Hunting is not allowed by either Adamera personnel or contractors, while working out of the camp. It is not part of the Adamera corporate activities, and most land use licenses do not permit it.
- f) Cordial relations are to be maintained with members of the local communities.

## **1.5. CAMP COMMUNICATIONS**

Contact Adamera’s head office for camp address and communications instructions.

When there is a satellite telephone in camp to is primarily to be used for communications related to technical or operational aspects. Incoming personal calls will be allowed only in the event of an emergency. Regardless of camp size, two way radio contact with either the expeditor or the driller or the airline must be arranged. If radios are used for communications, a time will be set up to call out to the local expeditor on a daily basis. Generally, the project geologist or an appointed person will make the radio calls. Please note that it is unlawful “to transmit any profane, indecent, or obscene language”.

A list of all important and emergency numbers must be available with each satellite phone unit.

Always tell your buddy or the project manager or the camp manager where you are going and if available, take a hand-held communication devise with you.

All drill rigs must also be equipped with their own satellite phones.

In situations where crews are dropped off by helicopter at a distance too far for 2-way radio communication, each work party is to carry a Globalstar, handheld satellite phone.

## **1.6. SMOKING**

There will be no smoking permitted in the following areas:

- the cooking/dining area
- the office tent, coreshack

- within 20 m of fuel, propane or explosive storage areas.

Smoking is permitted in sleeping tents only with the permission of your tent mates. If you are smoking outside, **do not throw butts on the ground – put them in an ashtray in a tent, or in the containers provided.** They may disappear in snow, but they are a real pain to pick up in the summer.

## **1.7. MISCELLANEOUS**

The type of work done in the field does require a certain amount of physical effort. Consequently, when people retire for the night, you will be expected to keep the noise down so as not to disturb their sleep. Although you may not need as much as others, you are expected to respect their wish to sleep.

Radios and tape/CD players are to be turned down no later than 10:00 p.m. If you wish to read, etc. and your buddy in the same tent wishes to sleep, it is suggested that you read etc. in the kitchen.

### **Personal Hygiene**

All employees are reminded that certain standards of cleanliness and decorum are to be maintained in the field camps. In particular, field clothes are to be washed regularly. Personnel are expected to wash regularly and **PARTICULARLY** before handling food. The excessive use of foul language will not be tolerated.

### **Wildlife/Visitors Log**

Wildlife and visitors logs will be kept in the kitchen tent. We encourage all personnel and contractors to note wildlife observed on the property and in the district. Visitors can be invited to sign in to our log, as well.

## SECTION B

### 2. PERSONAL SUPPLIES

The following is a suggested list of personal supplies required for the field season; it is presented as a guide for those employees who have not worked in the north. Included are items necessary for programs conducted under winter conditions.

- 1 Sleeping bag (quality equivalent to Arctic 3-Star. If you need further advice contact us).
  - 1 Small pillow (optional)
  - 1 or 2 Dunnage bags or pack sacks for personal belongings
  - 2 pr. Boots: winter. There is a variety available at better outdoors shops. Good boots should be rugged, fairly tall, have removable felt liners, and have ties or a fur ruff around the tops to prevent snow from falling in. Some suggestions are: Snow Paks (mukluk): rubber bottom/leather top boots with lining and ruff: skidoo type boots. Summer hiking or work boots.
  - 1 pr Rubber boots. These boots will be useful in the spring when the snow is melting and everything is sloppy. Try to get rubber boots with removable felts and a tie top.
  - 1 pr Extra felt liners
  - 1 pr Spare boot laces
  - 1 pr Running shoes, for use around camp
  - 8 pr Woolen socks
  - 3 pr Trousers – drillers drill – preferable loose fitting with no cuffs and zipper type fly. Many people wear denim jeans, but they are not very warm, they tend to absorb water, and are difficult to dry
  - 1 Parka – good quality; down
  - 1 Pants for outdoors use. Either heavy wool pants or ski pants. Insulated coveralls good for those doing lots of outdoors work
  - 2 Woolen sweaters
  - 1 Cap or hat
  - 1 Toque
  - 1 pr Warm (fleece lined) mitts or gloves – work gloves will be provided
  - 3 Work shirts
  - 3 T shirts
  - 1 or 2 pr Long underwear – sweat pants good
  - 2 pr Pajamas (optional)
  - 1 or 2 Towels
  - 1 Face cloth
  - 1 Washing/shaving kit, toothpaste, etc.
  - 1 Sewing kit – include a tube of clothing cement
  - 1 Pocket knife
  - 1 pr Spare prescription glasses
  - 1 pr Sunglasses – good quality. This item is very important!
  - 1 Watch (durable but inexpensive)
  - 1 Sun screen lotion
- Additional outdoors wear such as ski gloves & skidoo mask strongly recommended for winter.  
Stationery and stamps, reading materials, fishing rod.

\*Note Radio – rarely AM or FM reception, SW reception is poor to fair. Bring a portable tape/CD player if you wish, but also bring headphones so you don't inflict your taste in music on your tent mates! If your player needs batteries, make sure you bring up enough.

## SECTION C

### **3. SAFETY ON EXPLORATION PROJECTS**

On Adamera 's projects, a safety/first aid person will be identified. An orientation of safety/emergency procedures will be given in camp and a log of training be kept.

#### **3.1 SAFETY EQUIPMENT**

##### **3.1.1 CAMP**

Radios are provided in camp for SKEDS on a frequency to be identified. The local channel receiving emergency calls will be identified.

Safety equipment provided in camp includes a minimum of one fire extinguisher and smoke detector in each structure. If there is only one present, please leave the extinguisher by the door and ensure that it is always visible and easily accessible. Shovels, picks and pails should be on hand.

Locations of a comprehensive first aid kit and additional kits must be identified. Note: That first aid kits should be available from contractors, at the drills, and in the helicopter.

If there is a company shotgun it should be kept in the office tent, unloaded, with the chamber open, the location of emergency cartridges should be identified.

For the handling of fuel and coreboxes, gloves are to be worn. Personnel splitting/cutting drillcore should have gloves, safety goggles, masks and earplugs. **Note that it is important to use sage lifting techniques to avoid back and muscle related injuries. The attached pages suggest back care techniques and demonstrate proper lifting. Always ask for, or offer help!**

##### **3.1.2 FIELD**

Before leaving for the field, mark your route, will drop-off and pick-up points on the map in the office. Please ensure you always have the following safety items.

- Charged up handheld radio-return for recharging
- First aid kit
- Space blanket
- Helicopter flag
- Minimum one of: signal mirror, signal flare launcher with flares +/- bear bangers
- Bear spray (if desired)
- Safety goggles
- High energy food stash
- In winter, snowmobile helmets

##### **3.1.3 SURVIVAL GEAR**

For work outside of two-way radio communication range or more than several hours walk to camp ensure a survival pack is provided. Survival packs to include flares, bear bangers, first aid kit, heat source, thermal blankets, tent and small supply of lightweight food.

## 3.2 AIRCRAFT SAFETY

### General Considerations

During the field season, you may fly extensively in helicopters such as the Bell 206 which is a light turbine machine carrying up to 4 passengers plus pilot and cruises between 100-130 mph.

Commercial helicopter pilots are commercially-rated and have considerable wilderness flying experience. However, much of your safety depends upon you, observe the rules of conduct in and around helicopters. Be sure to ask your pilot to review safety considerations and desired methods of operation before you are a passenger.

The following points are note from past field seasons' experiences:

- a) Be an observant passenger, and help your pilot as well as yourself. Pointing out potentially dangerous situations which the pilot may not see may prevent tragic accidents. Help your pilot by checking to see that all disembarked passengers are away from the cargo door (which is on the side out of the pilot's vision). Watch for objects which may foul the rotors; loose tarps or plywood, a tree to close to rotor etc. This is normally the duty of the pilot but he may on occasion err and your help can prevent accidents.
- b) When approaching or leaving a running helicopter do not be hasty. Some people appear to panic and run to or away from the machine. Take your time so you will remember to keep your head low and either approach or leave the helicopter in view of the pilot and when he gives you the signal to approach or leave the machine.
- c) Keep your seatbelts on at all times and do not unbuckle until the pilot signals you to disembark. Helicopters have flipped over on landing.
- d) By law, the pilot is captain of the machine and makes all decisions regarding flying conditions. He will decide if it is safe to fly and he will pick the landing spots. If you have to walk an extra kilometre because of safe landing conditions, consider that this short walk is better than a bad accident.
- e) In the event that poor weather is setting in before the pick-up time, normally the pilot will go out early to pick-up the field crew. Each day you should arrange an alternative pick-up point with the pilot in case of such. If you hear the helicopter approach early and it appears to be circling the area, get into the nearest clearing and signal with flags. When possible field crews will be provided with hand-held VHF-FM radios to communicate to the camp and the helicopter pilot. Helicopter flags and signal mirrors help the pilot to better locate you in the field.
- f) Be sure to be at your pick-up spot at the time arranged with the pilot.
- g) Ask your pilot to inform you of any special considerations he has in regard to riding in or working around his helicopter.

### 3.2.1 SAFE OPERATING PROCEDURES FOR HELICOPTERS

Many rules and safety procedures apply equally to helicopters and fixed wing aircraft. However, helicopters are less safe because of their design and use. They are more susceptible to mechanical failure. The following safe operating procedures apply to helicopters, in addition to those previously listed for all aircraft.

- (a) **Do not use piston engine helicopters.**
- (b) **Never approach or exit a helicopter without the pilot's direct permission.** Pilots frequently do stability testing and shift the helicopter slightly before final landing.
- (c) **Approach a helicopter by moving toward the FRONT of it and in full view of the pilot.** Exit by moving away at the **FRONT** of the craft. Keep eye contact with the pilot if possible. Take care not to walk into the helicopter's radio antenna. You may have to approach or exit a helicopter to the side if it lands facing high ground as there is low blade clearance at the front of the helicopter. Never enter or exit toward the rear of a helicopter because the tail rotor is invisible when the machine is running.
- (d) **Always approach or exit a helicopter in a CROUCHING position** to give your head more clearance from the rotor blades. Hold on to your hat or hard hat if it is not secured with a chinstrap.
- (e) **NEVER WALK IN THE DIRECTION OF THE TAIL ROTOR.** If you walk into the tail rotor it will kill you! Inform the pilot before exiting if you must remove gear from the cargo compartment. Do this carefully, and make sure you close the cargo compartment door properly when finished. Then, return to the front in full view of the pilot and move away at the **FRONT** of the helicopter.
- (f) **Always approach and exit a helicopter using the DOWNHILL side if the craft is on a slope.** The rotor blades will be much closer to the ground on the uphill side and can hit your head. Be alert to the risks of moving through hummocky ground within the range of the main rotor blade.  
  
**NEVER exit in the UPHILL direction.**
- (g) **Do not approach or exit if the rotor blades are moving slowly.** Blades will dip as the motor slows and they can also dip unpredictably if it is windy.
- (h) **Do not approach a helicopter when visibility is reduced with blowing sand, dust or snow** from the downdraft of the rotors. Wait until visibility is clear or until the helicopter has shut down.
- (i) **Do not distract the pilot or upset the balance of the machine with sudden or unpredictable movements during take-off, landing or other maneuvers.** However, if you notice a hazard while flying, be sure to point it out to the pilot. Do not assume that the pilot has seen it.
- (j) **When loading and unloading, carry all long items horizontally (such as poles, oars, tools).** Never carry them vertically or over your shoulder as they may hit the main rotor blades.
- (k) **Never throw anything out of a helicopter.** It may contact the rotor blades or be sucked into the jet engines.

**NOTE: You must stay alert and constantly remind yourself to keep your distance from the rotor blades.**

### 3.2.2 **ADDITIONAL SAFETY PROCEDURES FOR HELICOPTERS**

- If you are exiting from a helicopter that will take off immediately, move at least 10 metres (30 feet) away with your gear and crouch down. Remain there while it lifts off.
- On rare occasions, pick-ups and drop-offs on steep slopes may require “toeing-in” with only partial support of the skids. Pilots should avoid toeing-in whenever possible. However, if this procedure is unavoidable, all passengers must be fully briefed on specific aspects of approach, exit, communication with the pilot and emergency procedures before departure. Board or exit only after you receive instruction and permission from the pilot. Be especially careful not to make any unexpected movements that suddenly redistribute weight during these landings.
- During some surveys, a helicopter door may be removed. Never unfasten your seat belt until the pilot gives permission.
- Never touch a helicopter or its load before it has completely landed, as it is usually charged with static electricity.
- When exiting, refasten seat belts so they don’t flap around inside the bobble or hang out the door.
- Protect your eyes from dust blown up when a helicopter is arriving or departing. Wear goggles or sunglasses.
- Stand back at least 15 metres (50 feet) from the landing pad when a helicopter is arriving or departing.
- Locate all fires at least 100 metres (300 feet) from a helipad so that turbulence created by flying activity will not blow embers about and create a brush fire.
- Always plan who will do what job when loading and unloading a helicopter. Who will communicate with the pilot? Who will hold the door? Who will carry which items? How will the items be carried? This helps prevent confusion and accidents.
- Never toss items from person to person when loading and unloading a helicopter.
- Securely stow all items within the bubble. Unsecured, small heavy items can cause a lot of damage in turbulence or a hard landing.
- Never place items against the bubble of the helicopter as they damage the surface or obstruct the pilot’s view.
- Close doors and cargo compartments carefully and completely.
- When moving or ferrying groups of workers, divide and load the cargo so that each flight carries sufficient food, shelter and sleeping bags for each passenger. Something may prevent the helicopter from completing all scheduled flights.

### **3.2.3 REGARDING THE MACHINE, THE PILOT MUST BE OBEYED AT ALL TIMES**

#### **Slinging**

If you are involved in slinging of fuel and/or equipment with the helicopter, review all procedures, the use of rigging and hand signals (see attached) with the pilot. It just be clearly understood who is sending/receiving and what is being transported. Handheld radios should be used. Arrange with the pilot a form of giving the OK for both yourself and the load. If you are asked to help with the slinging but are uncomfortable with the situation, please advise the project manager.

It is important to remember and constantly think about these things whenever you are around a helicopter. After a hard day in the field and a helicopter ride home it is all too easy to be half-witted when getting out and do something silly, and indeed it has been done many times with fatal consequences, by very experienced people.

With **FIXED WING AIRCRAFT**, the propellers are again the major danger area – keep well away or keep your eyes on them. However, you will often be engaged in loading or unloading aircraft. It is then important to take care not to bump or dent the fuselage or floats.

I hope these notes have not alarmed you (most of us enjoy flying); rather that they impress upon you the need to respect and value the aircraft you use. They are maintained in excellent condition and operated by experienced pilots.

Helicopters (which we use most) are very safe machines and are capable of landing safely almost anywhere in the event of a malfunction.

## **4. WATER SAFETY**

When using a boat for either work or play, please advise someone in camp of your intended route and approximate return time. Take a handheld radio with you and ensure the boat is in good condition before departure. The following items must be present; extra fuel, baling can (s), paddles, whistles (on lifejackets). Each person on board must be wearing a lifejacket (in good condition) appropriate to their weight. If you are a boat user, ensure that it is secure on shore after use, tied up. It should also be checked regularly to ensure it hasn't drifted away!

### **4.1 USE OF LIFEJACKETS**

All employees are to wear life preservers when:

- a) they are traveling in a company-owned or controlled boat or canoe.
- b) they are traveling on company business in any boat or canoe.

These regulations will be strictly enforced and personnel failing to comply with the regulations may be discharged.

Non-swimmers **MUST** wear a life jacket when in the water. The only exception is when washing or bathing, at the immediate shore, in water that is only a few feet deep (i.e. water up to your waist). Even the best swimmers are encouraged to wear a life jacket while swimming. **NEVER SWIM ALONE!** If you wish to go swimming, you **MUST** be accompanied by another member of the crew, or be in plain view of those on shore.



**Note:** A life jacket contains several plastic bags filled with absorbent material inside its cloth cover. A hole in the plastic ruins the jacket and makes it a hazard to life. Therefore, never use the life jackets as a cushion and avoid stepping on them.

## **5. WINTER SAFETY**

Some work may be done under extreme winter conditions. **It is crucial that you understand the principles of keeping warm, and avoiding such conditions as snow blindness, frostbite and hypothermia. Please read carefully the attached pages on these topics.**

Blowing snow can develop into whiteout conditions resulting in limited visibility both out in the field and within camp. During such “whiteouts”, travel (including movement between tents) should not be attempted unless a closely picketed and/or roped route is visible. Whiteout conditions are extremely dangerous, as it is possible to become disoriented within a few metres of a tent. Be prepared to wait out these conditions from a heated tent, or at the drill, if necessary.

Be wary of ice conditions, especially when the weather warms during spring. Be aware that thin ice conditions in the dead of winter may also exist in narrow channels of faster flowing water. Exercise caution near melting shorelines, as well.

## **6. SNOWMOBILE SAFETY**

If you are involved in winter or spring exploration programs, you may need to use snowmobiles for transport. If you are unfamiliar with the use of these vehicles, please travel with an experienced user and ask for operating instructions. Wear a helmet.

If you are unfamiliar with fueling requirements, ask. Attached is an excerpt from the CDDA safety manual, indicating regulations for traveling over ice, and instructions for the safe operation of snowmobiles.

## **7. ILLNESS LINKED TO COLD, HEAT AND ALTITUDE**

### **7.1 COLD-INDUCED ILLNESSES**

- 7.1.1 Hypothermia
- 7.1.2 Cold Water Immersion Hypothermia
- 7.1.3 Frostbite
- 7.1.4 Wind Chill Charts

Adamera Minerals Corp. employees work under many challenging environmental conditions: cold and windy, hot and humid or high altitude - which can be either hot or cold and windy. Exposure to temperature extremes and to high altitude can cause disorders with subtle and progressive symptoms that are difficult to accurately diagnose. Your body can function well only if your core body temperature (that of your heart, lungs, liver, kidneys and brain) remains very close to "normal", which is 37° C (98.6° F). You may tolerate a variation of  $\pm 1.5^{\circ}$  C ( $2.5^{\circ}$  F) from this optimum core temperature without much impact. A variation in your core temperature beyond this range will result in stresses that interfere with your biochemical processes and may result in a life-threatening condition. Your brain requires blood at the correct temperature and oxygen level in order for you to think clearly. For this reason, confusion and lack of muscular coordination are some of the symptoms of hypothermia, hyperthermia and altitude sickness. Your body controls its internal and surface temperatures through processes that result in heat loss and heat gain. Heat loss takes place through evaporation, convection, conduction and radiation from your skin surface and by respiration from your lungs. Heat gain is a function of your metabolism and activity level. Under extremely hot conditions you may

experience heat gain through radiation from the sun and/or your environment. To a great extent, you can control heat loss and heat gain through your behavior (e.g., food and water intake, clothing, exercise, rest). Therefore, preparation and the use of proper equipment play a major role in preventing hypothermia, hyperthermia and altitude sickness. Thorough preparation and understanding of these environmental disorders may save your life or that of a co-worker.

### **7.1.1 HYPOTHERMIA**

Hypothermia occurs when your core body temperature falls to a level where internal organs cease to function effectively. As a result, your body loses heat faster than you can produce it through metabolism and exercise. Hypothermia can develop quickly and it can be fatal. Wet, cold, windy weather combined with hard physical effort can lead to exhaustion and leave you vulnerable to hypothermia. Temperatures need not be especially cold for hypothermia to develop; it frequently sets in at temperatures between -1° C to 10° C (30° F to 50° F). Field crews should watch out for early warning signs of hypothermia; the buddy system is the most effective way to monitor each other. This is vital because **victims often do not recognize their own symptoms**. If there is the slightest chance that someone is suffering from hypothermia, never leave the person alone or let them wander off, as their condition may suddenly deteriorate. You can prevent hypothermia. Be prepared by being **well nourished, well hydrated, well rested and properly dressed**. Use good judgment and respect safe outdoor procedures.

#### **Symptoms**

Hypothermia is a progressive disorder. Mild hypothermia can be treated in the field, but severe hypothermia is life-threatening and is extremely difficult to treat in the field. Therefore, it is vitally important to recognize and deal with the early symptoms so that hypothermia does not progress to a severe stage. There are both physical and behavioral symptoms. Early symptoms can be subtle and hard to recognize and no single symptom is diagnostic of hypothermia.

**Here is a list of progressive symptoms.** (The victim's body core temperature range is shown.)

#### **Mild hypothermia (35-36° C) (95-97° F)**

- Cold extremities - feeling cold and numb is the first symptom
- Shivering - may be intermittent or constant and uncontrolled
- Tachycardia (fast heart rate)
- Tachypnea (fast breathing)
- Urinary urgency
- Slight incoordination - has some difficulty performing tasks with the fingers and hands

A person with mild hypothermia may be alert and answer questions sensibly. He or she is focused on getting warm rather than the task at hand. A person may just appear "tired" when he or she is actually hypothermic. **It is very important to treat a hypothermic victim at this stage. Do not allow him or her to become colder.**

#### **Moderate hypothermia (32-34° C) (90-93° F)**

- Increased incoordination and clumsiness - may stumble frequently
- Fatigue - wants to rest or go to sleep
- Reduced shivering
- Slurred speech and amnesia
- Weakness and drowsiness

- Apathy, poor judgment
- Dehydration

A person with moderate hypothermia stumbles frequently and is uncooperative and confused. Speech is slurred and shivering may cease as the victim loses more body heat. The victim may wish to be left alone. A victim of moderate hypothermia is in grave danger and may die if hypothermia progresses.

#### **Severe hypothermia (<32° C) (<90° F)**

- Total loss of shivering
- Inappropriate behavior
- Reduced level of consciousness
- Muscle rigidity
- Bradycardia (slow heart rate) and low blood pressure
- Cardiac arrhythmia (irregular heart rhythm)

The inability to walk or stand indicates severe hypothermia. A person who appears asleep may actually be in a coma. Severe hypothermia cannot be treated in the field so evacuation to a medical facility is necessary.

To help remember the symptoms of mild hypothermia, a mnemonic from *Medicine for Mountaineering & Other Wilderness Activities*, by James A. Wilkerson is very helpful:

**“A person fumbles, mumbles and grumbles stumbles and tumbles.”**

#### **Treatment**

Take immediate action when you encounter someone suffering from hypothermia. **Prevent the victim from losing more body heat.** You can treat mild hypothermia in the field. For severe hypothermia, stabilize the victim to stop further heat loss and **gently** transport him or her to a medical facility. Rough handling may cause ventricular fibrillation due to the presence of an irregular heart rhythm, which often results in death.

1. **Get the victim into some sort of shelter.** If there is no indoor shelter, use whatever is available - a tent, an overturned canoe, a space blanket or tarp, branches, rocks or snow for a windbreak. Build a fire as soon as possible. Beware of possible carbon monoxide poisoning from a heat source in an enclosed space. Carbon monoxide directly reduces the oxygen-carrying capacity of your blood. This effect increases with altitude. Do not allow a victim to cool further.
2. **Remove the victim's wet clothes gently without exposing the victim's bare skin to wind or rain,** if possible. A group can share dry clothing to the extent that no other member becomes endangered.
3. **The ideal way to warm a victim** is to place him or her, stripped, in a warmed sleeping bag next to or between one or two other stripped people who are-not suffering from hypothermia. Their body heat will warm the victim. You can place warmed objects such as chemical hot-packs, hot water bottles or even heated rocks next to the victim, if they are wrapped to prevent burning. Only place warmed objects around the chest; do not warm peripheries (limbs) initially, as this can cause the peripheral blood vessels to dilate and result in a drop in blood pressure. Peripheral blood vessel dilatation also allows cooler peripheral blood to enter central circulation (body core) and can cause core temperature to drop further, a condition known as "afterdrop". Insulate all their extremities (hat, gloves, socks, etc.) to prevent further heat loss. Keeping the head covered is most important, as 30% of body heat can be lost from the head.

**The following measures will also help treat hypothermia**

- **Give warm drinks** (without caffeine or alcohol) to a victim who is conscious and not shivering uncontrollably. Drinks may be sweetened with sugar.
- **Always handle the victim gently.** Do not rub the skin or make the victim perform vigorous exercise; rough handling can cause cardiac problems.
- A victim should avoid unnecessary activity, as this circulates cold blood from extremities into the body core, further reducing the temperature and increasing the rate of heat loss.
- Seek medical attention as soon as possible; complications frequently develop with hypothermia.
- Severe hypothermia may result in respiration and pulse rates that are undetectable (the pulse may be less than 20 beats per minute and even as low as one beat per minute). For this reason, never consider a victim to be dead until he or she is "warmed and dead".

### Prevention of Hypothermia

1. **Stay Warm**
2. **Stay Dry**
3. **Avoid Fatigue**

### Pay strict attention to the following tips and you will avoid hypothermia.

- Dress intelligently and appropriately. Wear a wool hat. Wear several layers of loose-fitting clothing with enough space between each layer to entrap 4 mm or 1/4 inch of air. Wool clothing is recommended, as it retains 80% of its insulating qualities even when wet. New polar fleece fabrics offer good warmth. Down is a good insulator only when it is dry. Try to avoid 100% cotton as it provides minimal insulation even when dry. If it is wet, it conducts heat away from your body many times faster than wool. Wear an external windproof layer. Always carry waterproof rain gear, preferably the "breathable" kind, as it allows perspiration to escape. Put on rain gear *before* you get wet for the most effective protection.
- **Try to maintain a comfortable body temperature.** Try not to work up a sweat as wet clothes may chill you. To cool down, remove your gloves first (if your hands won't be exposed to ice or snow). Next, remove your hat and scarf exposing your neck area. Then, loosen the clothing at your wrists and waist. Finally, remove layers of clothing. A polar fleece or down vest helps keep your trunk warm and allows your arms to remain cool.
- **Rest frequently to avoid fatigue.** Fatigue is often the factor that aggravates a difficult situation. When resting, take shelter from the wind and make certain that you sit on something (such as your pack) for insulation from the ground or snow. Always stop to make camp before fatigue sets in. It is easier to warm up if you are not fatigued.
- **Your body cannot combat the cold efficiently if you are dehydrated or hungry.** Snack often on high-energy foods and drink plenty of fluids. **Carry waterproof matches** so you can make a fire and a hot drink, if necessary.
- **Be on the lookout for symptoms in yourself and others.** If you recognize and address the early symptoms, you can avoid further problems. Always believe the symptoms, not the victim, as he or she may not recognize them.
- **Learn to recognize weather conditions that may cause hypothermia.** Be prepared.
- **Beware of wind chill.** The cooling effect of wind on your body can be enormous. Wear windproof clothing, a hat and take shelter from the wind, if necessary. *See Wind Chill Charts 6.1.4.*

### 7.1.2 COLD WATER IMMERSION HYPOTHERMIA

Hypothermia develops swiftly if you capsize a canoe, fall into cold water (less than 10° C or 50° F) or fall through ice. Water in this temperature range rapidly conducts heat away from your body. Your body cools so quickly that you cannot breathe properly and your hands become numb. You lose good judgment quickly as your core body temperature falls. **Always carry waterproof matches and a knife in your pocket so you can build a fire to dry out and warm up in case of accident.** Carry a day pack containing dry clothing. Whenever you operate a boat, it is mandatory to wear either a Personal Flotation Device (PFD) or a floater jacket, as this is the most effective defense against cold water immersion hypothermia. It is important to treat anyone rescued from cold water immersion as a hypothermia or shock victim.

**If you must work on ice,** your party must take a waterproof hypothermia kit on traverses.

#### **If you fall through ice into cold water:**

- Remove your snowshoes or skis and place them on the ice to help bear your weight.
- Extend your arms in front of you and kick your feet to the surface so you are in a horizontal position. While on your stomach, kick hard to heave or lift yourself out of the water up onto the ice - keeping your weight spread out over the ice. Lean on your skis or snowshoes to spread out your weight. Once you are out of the water, roll to stronger ice. If the ice is soft or thin, you may have to break your way to stronger ice or to shore. Stand up only when you reach ice that is strong enough to bear your weight.
- Once you are on safe ground, build a fire immediately. Concentrate on warming your head and trunk area. Put on dry clothing. If none is available, remove your articles of clothing one at a time. Wring them out and put them back on.

#### **If you capsize your boat or fall into cold water:**

- **Don't panic.** Immediately do any necessary jobs that require the use of your hands. Get rid of your pack and heavy boots. Retrieve your whistle, flare gun, paddles, etc. Climb back into the boat - or onto it - if it is overturned and you cannot right it.
- **Stay with your boat.** You lose body heat 35% faster when you are swimming than when you remain still (this includes treading water). In cold water, you can only swim one-tenth to one-fourth the distance you can normally swim in warm water. It is almost always safer to paddle or drift to shore with the boat.
- **Always get as much of your body as possible out of the water.** You lose core body heat much faster in the water than the air. **Try to get back into the boat and bail water out of it.** Crouch low to stay out of the wind as you paddle to shore.
- **If you cannot get back into your boat,** climb up onto the overturned boat and tie yourself to your partner with a belt or rope.
- Do not discard clothing or lightweight shoes if you capsize. They help you retain body heat while you are in the water. Discard your field boots *only* if they are heavy. Button up your clothing and cover your head to help preserve body heat.
- Use your emergency whistle, flare gun or an air horn to attract attention.
- Swim for shore *only* if the shoreline is very close. Your swimming abilities are much diminished by cold water, heavy clothing and shock so it is nearly always safer to stay with the boat. If you choose to swim to shore, check the wind direction to make sure it will not blow you offshore.

- Eat any food (e.g., candy bars) that you have available to supply your body with energy to combat hypothermia.
- Once on shore, build a fire immediately. Concentrate on warming your head and trunk area. Put on dry clothing. If none is available, remove your articles of clothing one at a time. Wring them out and put them back on.
- If you cannot get out of the water, assume the **HELP** position. **HELP** is an acronym for **H**eat **E**scape **L**essening **P**osture.

### HEAT ESCAPE LESSENING POSTURE



**If you are alone**



**If you capsize with a group**

**If you are alone**, this position minimizes heat loss from your torso area. You must be wearing a PFD. Try to wear a hat to minimize heat loss from your head.

1. Cross your arms tightly across your chest.
2. Draw your knees up close to your chest.
3. Stay still. Do not expend energy moving around.

**If you capsize with a group of people**, huddle together to minimize heat loss. Again, you must all be wearing PFDs.

1. Form a circle facing inward so that your chests are close together.
2. Place your arms around the back of each person next to you.
3. Intertwine your legs.

### **7.1.3 FROSTBITE**

Frostbite occurs when your body tissue actually freezes. It most commonly affects the toes, fingers, ears, nose, and face - especially the chin and throat. Hypothermia and frostbite often develop at the same time and wind chill is frequently a contributing factor. Use the buddy system to watch for signs of frostbite in yourself and other members of your field party.

## Symptoms

- White or gray patchy skin develops on the face, fingers or toes
- Pain in these extremities is present although it gradually disappears as frostbite develops.
- Skin does not move easily over the knuckles or toes; it becomes hard and waxy.

## Treatment

- Superficial frostbite may be treated in the field; deep frostbite should be treated at a medical center.
- Never thaw frostbitten tissue if it is likely to refreeze as this causes permanent tissue damage. Move the victim to a medical facility for thawing procedures.
- **Do not rub affected areas** with anything. Never thaw the area with direct heat (e.g., fire, heating pad, chemical hot packs).
- Thaw the affected area rapidly in a tub of warm water 40°- 44° C or 104°-111° F. This temperature is important. Suspend the affected limb in the water so that it does not touch the sides of the tub. If the ears or face are affected and cannot be submerged, use hot compresses maintained at this temperature. This procedure is painful and should be done in a medical facility, if possible.
- Protect the thawed areas with sterile dressings especially between affected fingers and toes. Keep the victim warm to promote good circulation.
- Do **NOT** break the blisters that may form.
- Seek medical attention as soon as possible.





## Prevention

- Stay warm and stay dry. Many precautions you take to prevent hypothermia apply to frostbite.
- Recognize the importance of the wind chill on exposed flesh in freezing temperatures (*see* Wind Chill Charts 6.1.4).
- Pay attention to those areas of your body that may be exposed to the cold. Dress accordingly. A balaclava or face mask will protect your face (especially your chin and throat) better than a hat alone. Avoid clothing such as tight boots and gloves that might restrict your circulation.
- Don't wear extra socks if this will cause your boots to fit too tightly.
- Wiggle your fingers and toes occasionally to encourage circulation.
- Wear gloves when handling volatile fuels, as these products may cause immediate frostbite if they come in contact with your bare skin. Cold metal surfaces can do the same.

## 7.1.4 WIND CHILL CHARTS

### Metric Wind Chill Chart

Wind Speed $V_{10}$	Metric Units Wind Chill Calculation Chart											
	T air – Air Temperature in °C and $V_{10}$ = Observed wind speed at 10m elevation, in km/h.											
Km/h	T air (°C)											
Calm	5	0	-5	-10	-15	-20	-25	-30	-35	-40	-45	-50
5	4	-2	-2	-13	-19	-24	-30	-36	-41	-47	-53	-58
10	3	-3	-3	-15	-21	-27	-33	-39	-45	-51	-57	-63
15	2	-4	-4	-17	-23	-29	-35	-41	-48	-54	-60	-66
20	1	-5	-5	-18	-24	-31	-37	-43	-49	-56	-62	-67
25	1	-6	-6	-19	-25	-32	-38	-45	-51	-57	-64	-70
30	0	-7	-7	-20	-26	-33	-39	-46	-52	-59	-65	-72
35	0	-7	-7	-20	-27	-33	-40	-47	-53	-60	-66	-73
40	-1	-7	-7	-21	-27	-34	-41	-48	-54	-61	-68	-74
45	-1	-8	-8	-21	-28	-35	-42	-48	-55	-62	-69	-75
50	-2	-8	-8	-22	-29	-35	-42	-49	-56	-63	-70	-76
55	-2	-9	-9	-22	-29	-36	-43	-50	-57	-63	-70	-77
60	-2	-9	-9	-23	-30	-37	-43	-50	-57	-64	-71	-78
65	-2	-9	-9	-23	-30	-37	-44	-51	-58	-65	-72	-79
70	-2	-9	-9	-23	-30	-37	-44	-51	-59	-66	-73	-80
75	-3	-10	-10	-24	-31	-38	-45	-52	-59	-66	-73	-80
80	-3	-10	-10	-24	-31	-38	-45	-52	-60	-67	-74	-81

	<b>Wind Chill</b> 0 to -24°C 32 to -11°F	<b>Hazard</b> Risk of hypothermia if outside for long periods Little danger of frostbite if properly clothed
	-25 to -44°C -13 to -47°F	Frostbite is possible in 10 minutes (warm skin suddenly exposed).
	-45 to -59°C -49 to -74°F	Frostbite is possible in less than 5 minutes. Exposed skin may freeze in minutes
	-60°C and colder -74°F and colder	Extreme danger of frostbite within 2 minutes Outdoor conditions are extremely hazardous.

**NOTE:** In cold temperatures if you are riding on an open vehicle such as snowmobile or ATV, your exposure to wind chill effect increases the faster you travel



### Imperial Wind Chill Chart

Wind Speed mph	English Units Wind Chill Calculation Chart															
	T air – Air Temperature in °C and V <sub>10</sub> = Observed wind speed at 10m elevation, in km/h. T air (°F)															
Calm	30	25	20	15	10	5	-0	-5	-10	-15	-20	-25	-30	-35	-40	-45
5	25	19	13	7	1	-5	-11	-16	-22	-28	-34	-40	-46	-52	-57	-63
10	21	15	9	3	-4	-10	-16	-22	-28	-35	-41	-47	-53	-59	-66	-72
15	19	13	6	0	-7	-13	-19	-26	-32	-39	-45	-51	-58	-64	-71	-77
20	17	11	4	-2	-9	-15	-22	-29	-35	-42	-48	-55	-61	-68	-74	-81
25	16	9	3	-4	-11	-17	-24	-31	-37	-44	-51	-58	-64	-71	-78	-84
30	15	8	1	-5	-12	-19	-26	-33	-39	-46	-53	-60	-67	-73	-80	-87
35	14	7	0	-7	-14	-21	-27	-34	-41	-48	-55	-62	-69	-76	-82	-89
40	13	6	-1	-8	-15	-22	-29	-36	-43	-50	-57	-64	-71	-78	-84	-91
45	12	5	-2	-9	-16	-23	-30	-37	-44	-51	-58	-65	-72	-79	-86	-93
50	12	4	-3	-10	-17	-24	-31	-38	-45	-52	-60	-67	-74	-81	-88	-95
55	11	4	-3	-11	-18	-25	-32	-39	-46	-54	-61	-68	-75	-82	-89	-97
60	10	3	-4	-11	-19	-26	-33	-40	-48	-55	-62	-69	-76	-84	-91	-98

## 8. CAMP CLEANLINESS

The operation of our camps is done in compliance with various Land Use Regulations.

These regulations provide for a healthy and sanitary camp operation, and for fuel handling, garbage, and sewage disposals, etc. The regulations are enforceable. Failure to comply with any aspect of these regulations can result in withdrawal of a Land Use Permit – which would result in closing of the camp.

Apart from the legal considerations, most of the regulations express common sense ideas to which any individual should adhere.

Thus care is taken to burn garbage regularly, dispose of sewage and waste water, not leave the waste paper – or any waste materials – around the camp, to store fuel, etc. well away from streams and lakes. These are everyday common sense chores in which every camp member participates.

Garbage should be burned daily (weather and wind permitting). Use of incinerators made of empty 45-gallon drums with the top taken off and many holes punched in the side. Burning is helped by dousing of fuel left over from other purposes (see FUEL section). Diesel and stove oil are best for burning garbage as they burn more slowly. NEVER USE NAPHTHA OR GASOLINE. Stand across wind when lighting the drum – stand well back and touch it off with a long pole with burning paper in the end.

Make sure that each load is fully burned. Incomplete burned garbage can attract bears and is scattered far and wide by scavenging seagulls. Complete combustion is facilitated by a good supply of oxygen – hence lots of holes in the drum, regular burning, and slow feeding in of garbage. The burnt garbage is then double bagged and taken from the camp back to town either by air or overland. **Care has to be taken not to set vegetation on fire around the incinerators or the pits. Personnel burning garbage should advise someone in camp and have a handheld radio, pails or sand/water and shovels present.**

Solid sewage can be burned if you have a good incinerator system, otherwise it should be buried with a good dose of lime to help break it down and discourage the attention of bears. In winter camps, burn it with the garbage. Soak each honey bag with a couple of litres of stove oil and let it sit at least an hour before burning.

Depending on the type of ground, waste water can simply be allowed to soak into the ground or sometimes may need to be pumped to a suitable sump. Care should be taken that it does not run off into nearby streams or lakes. Water for camp use – draining, working, cooking etc., is usually pumped up or pailed from the lake or stream where one is camped. Check the water quality before using. Keeping water tanks filled in the winter is always a big job. Pumps and hoses must be drained quickly after filling is completed to avoid freezing and returned to the dry. We'll review this in the camp.

Most exploration camps are temporary affairs. It is therefore important that camps are cleaned up upon completion of a program so that there is virtually no evidence of the occupation of that site. A little care taken during the operation of a camp will facilitate cleaning up of that site at the end of the program, leaving the land clean for the use and enjoyment of subsequent visitors and the residents.

## 9. FUEL HANDLING

### Fuel Handling

Camps often require a variety of fuels. These are commonly stored in 45-gallon (200 litre) fuel drums or in smaller drums and jerry cans. Some fuels are compressed gases and are stored in cylinders that require special handling (eg. propane).

- Fuel Storage areas must be at least 100 metres away from the camp. Clear vegetation to reduce the risk of fire and create a berm around the area, if necessary. **DO NOT SMOKE WITHIN 20 METRES OF THE FUEL STORAGE AREAS**
- Store each type of fuel in a separate pile. It is important not to mix them up. Always store aviation fuel separately from all other fuels. Mark fuel drums with Diamonds North's ownership when required.
- Most drums are clearly marked but occasionally markings are erased. **If in doubt about the identity of a fuel – DO NOT USE IT. Report it to your camp manager.**
- Drums should be stored lying down on their side with both bungs at the same level when not in use. This prevents air and moisture from entering.
- When a drum is in use, elevate one edge of the drum with a rock or a piece of wood. Place the drum so water does not collect on the top of the drum and run into the fuel drum through the bungs.
- DO not expect pilots to use fuel that is more than two years old or if the bung seals are damaged.
- When transferring fuel to smaller containers, label each container clearly.
- Use hand or power pumps to empty the drums into jerry cans. Use a flash or spark arrester when transferring fuel between containers to prevent a static spark from occurring. Try to use metal fuel containers; avoid the use of plastic fuel containers whenever possible. Never use your mouth to siphon fuel. There are usually one or two gallons of fuel left at the bottoms of drums. This is often dirty due to rust and sediment from the sides of the drums. However, this fuel should be saved – tipped into collecting drum – and used for burning garbage.
- If you must use the same pump for various fuels, make sure you flush it out first and empty the waste into a bucket – never onto the ground. Label the waste fuel container – this fuel can be used for burning garbage unless it is pure NAPHTHA or GASOLINE.
- Smoking is never permitted within 20 metres of fuel storage areas.
- Know the correct fuel for each piece of mechanical equipment. Check the manual or ask someone who knows. All fuel required for machinery must be properly filtered. Use funnels whenever necessary to avoid spillage, e.g. when filling heaters.
- Refrain from refilling drums, If refilling a drum is unavoidable, do the following:
  1. Use the same type of drum.
  2. Closely inspect the drum for cleanliness inside and out and ensure it is not damaged
  3. Thoroughly rinse the drum with the fuel that will fill the drum. This avoids contamination.
  4. Label the contents on the outside of the drum with indelible markings.
  5. Properly dispose of the fuel used to rinse the drum.
- Transport fuel drums and gas cylinders upright in the back of pickup trucks - never in the cab. Most drums are marked so there should be no reason to mix fuels. However, the following

distinguishing features should help in case drums have had their markings erased. Carefully secure all drums and tanks so they cannot shift while underway.

- All personnel must read and sign off on the Company's Fuel Spill Contingency Plan.

Jet B; also known as Turbo B, JP4	Jet Helicopter Twin Otter Turbo Beaver Sharp Heater	Very pale straw colour, almost clear. Could be confused with Naptha. Has oilier smell than Naptha.
Avgas 100/130	Single Otter Piston Helicopter Standard Beaver DC-3 Cessna 185	Yellowish, sickly sweet smell
Naptha	Coleman Stove Lanterns Coleman Heater	Clear, is a lighter fuel than Jet B. Evaporates more rapidly than Jet B. Leaky drums may have crystalline deposits at the leak in cold weather. Feels cold due to high evaporation.
Regular Gas	Small Generators (Honda 1500 or Honda 300) Skidoos	Slightly yellow, same smell, etc. as the regular gas you put in your car.
Diesel	Large Generators Oil Stoves	Noticeably heavier than the other fuels. Smell of old stoves.
Stove Oil	Oil Stoves	As for diesel.

## **10. TENT MAINTENANCE**

You will encounter a variety of these during the summer. The common factor linking them is their construction out of fabric which can easily rip or wear out in windy conditions north of the treeline.

Don't go away from your tent for any length of time leaving the door open. The wind can then get in and tear the door area.

Some tents have zipper doors. Don't leave the zip half open – the stress can rip the zip from the tent.

Don't let objects touch the fabric – rain will seep in at such points.

Keep heaters and lanterns away from the fabric and be wary of drafts affecting the heater's flame.

In addition to maintaining your own tent, keep an eye on the communal tents, e.g., cook tent (very important, storage and office tents, or any tents whose occupants are not in camp).

Usually this will just involve securing tent pegs and ropes in the face of a brewing storm, but heaters may need checking.

Do not write on the tents.

Sometimes it is necessary to nail part of the tent to its wooden frame, for example, around the floor. Try to do this so as not to rip the canvas; fold the canvas double if possible or use its own double seams. Hold the canvas down with some lath so that the canvas is clamped rather than nailed.

When the tent is dismantled, the lath can be easily pried out without ripping the canvas and just leaving the small punctures made by the nails.

Do not make the front of the tent too tight – you may stress and rip the doors – whether zip types or ties.

## **11. MECHANICAL EQUIPMENT**

If you are not mechanically minded ask someone to show you how to operate the generator, water pump, skidoo, chain saw etc.

They are all basically simple to operate and maintain, but are usually troublesome to repair. Thus care taken in their operation will be well rewarded.

The simplest cause of trouble is lack of oil – check this each time before you use the machine. If you are on the skidoo, make sure you have enough gas.

### **TAKE CARE TO USE THE RIGHT FUEL:**

GENERATORS	Some run on regular gas, some on diesel.	
	<u>Fuel</u>	<u>Gas</u>
SKIDOO	50:1 Gas: Oil Mixture	Chain case periodically
OUTBOARD MOTOR	40:1 Gas	Oil Mixture
CHAIN SAW	20:1 Oil: Gas Mixture	Chain case oil – check every time used
WATER PUMP	Regular Gas	

**EVERY MACHINE IS DIFFERENT – CHECK THE MANUAL, OR ASK SOMEONE WHO KNOWS**

## **12. HEATERS AND LANTERNS**

### **Camp Lanterns and Heating Stoves**

Most camps contain a variety of lanterns and heaters. Each type has different controls and characteristics. If you have not used a particular type before, read the instructions and ask questions of someone experienced with its use. Propane or battery-powered lanterns are safest. Lanterns that run on flammable liquid can be knocked over and spill fuel that may result in a rapidly spreading fire. **Hang lanterns from the ceiling.** They are more easily overturned if they are placed on a table.

## **Heaters**

There are a variety of heaters present in most camps. Each type has different controls and idiosyncrasies. If you have not used a particular type of heater before read the instructions on it and ask someone experienced in using them what the tricks of the trade are:

## Heating stoves in tents

- New stoves and pipes will smoke as the protective coating bums off. Make sure there is good ventilation as this smoke may be toxic.
- When you use any heaters, always check that your tent is **well ventilated but not drafty**. Carbon monoxide and toxic fumes are significant hazards.
- Place oil and wood stoves at least 1 metre from any flammable material (e.g., tents, beds and clothes).
- Place a heat resistant barrier on the walls nearest the stove. Use aluminum, foil, which will also reflect heat around the tent.
- Place insulation between the chimney and the support pole whenever an outside chimney needs a support pole. Brace and wire all pipes until they are solid enough to withstand a windstorm. Make sure the chimney does, not touch the tent and that the chimney vent that passes through the tent is made of adequate insulating material.
- Use a heat-resistant spark arrester on oil and wood stoves.
- If an oil stove is **HOT**, turn off the oil and do not light it again until the firepot cools. Oil evaporates when it seeps into a hot firepot and this may cause an explosion,
- Do not move kerosene heaters when lit.
- Clean oil stove filters regularly. Use a soot remover and vacuum at least once a week when stoves are frequently used.
- Frequently inspect all fuel lines (hoses). Rubber hoses are superior to copper piping.
- **Remember to turn stoves down or off when the tent or camp is not occupied.**

## Meltdowns have occurred from the misuse of heaters when:

- The wrong type of fuel was used.
- The operator was smoking while fuelling up.
- Insufficient care was taken when lighting them.

TYPE OF HEATER	FUEL USED
PROPANE	Propane
KEROSENE (Sharp, Toyoset)	JP-4, JET B, Kerosene
CATALYTIC, e.g., Coleman	Naphtha
STANDARD types of stoves	Diesel, Stove Oil

The SHARP and TOYOSET heaters should not be carried when alight. If a heater runs out of fuel, let it cool and make sure it is out before refueling it.

Keep the heaters in the communal tents topped up; especially in the cook tent.

## Lanterns

In large camps you will likely have tents with electric lights fed from the camp's generator. You may find yourself using propane lights or more commonly COLEMAN lanterns. These use Naptha and again can be temperamental and require care when lighting.

### Follow these precautions when using lanterns:

- Use the correct fuel.
- Light the lantern outside the tent.
- Light the match before turning on the fuel.
- Do not pump the lantern too hard at first.
- Pump a lantern carefully once the flame is going smoothly.
- Never smoke while lighting lanterns and stoves.
- Place lanterns far enough away from the walls and ceiling so the heat radiating from them does not set the tent on fire.
- Keep burning lanterns away from fuel drums, cans or tanks that contain (or have contained) flammable liquids.
- Be careful when you take down a hanging lantern. Use a glove or stick, as the handle may be very hot.
- If a lantern runs dry, let it **cool off** and make sure it is **out** before you open and refuel it. Fuel will vaporize when poured into a hot lamp and an explosion may result.
- When lighting a new mantle let it bum in the open air for 15 minutes. This will allow toxic amounts of beryllium and thorium to dissipate

## Firearms

- There are very limited circumstances where the need may exist to use firearms to protect employees from wild animal attack. If it is deemed necessary to keep firearms in camp and to carry a firearm in the field (i.e., on traverse), approval must be obtained from the Vice President, Exploration.
- All employees required to use firearms must have appropriate training and a license in accordance with the codes, statutes or laws of the local jurisdiction (e.g., Firearms Acquisition Certificate in Canada). Employees must obey the Adamera guidelines and procedures regarding use of firearms.
- Adamera employees and contractors may not possess, carry or use personal firearms on Company premises or while on Company business except with the written approval of the Vice President, Exploration.
- Firearms must never be used for hunting while in or around camps or field operations.
- Firearms must only be used for the protection of life. They must not be drawn or discharged to defend Adamera property.
- Contractors must follow the Adamera firearms guidelines or policies when employed by Adamera.
- Violation of the firearms regulations and rules may result in Company disciplinary actions up to and including dismissal.



## **13. SURVIVAL**

- 13.1 HOW TO PREVENT A SURVIVAL SITUATION**
  - 13.1.1 Preparation to Prevent Survival Situations
  - 13.1.2 Routines to Prevent Survival Situations
- 13.2 PREPARATION TO CONFRONT A SURVIVAL SITUATION**
- 13.3 SURVIVAL EQUIPMENT LISTS**
- 13.4 GENERAL ADVICE FOR SURVIVAL SITUATIONS**
  - 13.4.1 Survival Advice for Cold Climate Conditions
- 13.5 PRIORITIES IN A SURVIVAL SITUATION**
  - 13.5.1 First Aid
  - 13.5.2 Location
  - 13.5.3 Shelter
  - 13.5.4 Fire
  - 13.5.5 Water and Food
  - 13.5.6 Signalling
- 13.6 IMPROVISATION AS A SURVIVAL STRATEGY**

Adamera employees often work in hostile environments where the possibility of facing a survival situation is real. The attitude that "it can't happen to me" is unacceptable because no employee is immune to accidents or unexpected danger.

### **An emergency could happen if:**

- You get lost in the bush
- Your vehicle breaks down in a remote area or in harsh climatic conditions
- An aircraft fails to pick you up due to sudden weather changes or a mechanical breakdown
- The water becomes too rough for a safe boat passage
- Water levels rise so streams become impassable
- Adverse weather conditions suddenly develop

### **Or worse:**

- Personal injury on a traverse
- A helicopter or plane crash
- A wild animal attack
- A kidnapping

Survival is a subject of great importance for each field employee. During daily field routines, what may begin as a series of small predicaments may escalate into a serious situation. It is far easier to address the small problems over which you may have some control than to cope with a situation that has grown out of control.

This chapter addresses:

1. Planning and preparation measures to help you prevent survival situations
2. Planning and preparation strategies to help you cope with a survival situation
3. Routines, skills and priorities to help you confront an emergency situation

With this knowledge, you should feel more confident should you face a crisis.

**Remember that survival situations are not limited to remote areas.** You could face a crisis situation due to weather conditions or a transportation accident, yet be near civilization. Therefore, you need survival equipment with you on every job at all times.

**If you suddenly face a survival situation,** you can expect rescue within an interval of between a few hours and 2 to 3 days – if you have followed the established communications procedures with your camp manager or supervisor. **Co-workers must know your location, your destination, your route and any change of plans, as well as your expected time of return or contact.** With this information, if you do not return or make contact at the appointed time, a search can be initiated shortly thereafter. Adamera will search until you are found.

### **13.1 HOW TO PREVENT A SURVIVAL SITUATION**

#### **Prior Planning and Preparation Prevents Poor Performance**

This principle of "6P's" is a more comprehensive catch phrase than "be prepared". Prior planning and preparation will supply you with necessary knowledge of equipment use, skills and the mental attitude to prevent or confront a survival situation.

##### **13.1.1 Preparation to Prevent Survival Situations**

**To prevent survival situations from developing, you must understand the factors that cause them.** Two major risks originate with you - your attitude and physical well being. Self-confidence, dehydration and fatigue will affect your mental and physical condition. Therefore you need to analyze your mental and physical condition in addition to changing weather conditions and hazardous terrain. Learn to recognize when various risks are adding up. Understand how a simple problem, or a series of simple problems, can escalate into a very serious situation.

You must begin each day prepared to face the weather conditions and terrain where you will work. Take into account the mode of transportation you will use to get to the work site. This means:

1. Wear clothing that will protect your body from heat, cold and dehydration. Take enough clothing to meet the worst weather you may encounter that day *plus* enough to get you through a night should you be forced to remain away from camp. Dress in layers that allow for ventilation as you work. Carry insulating outer wear and rain gear, whenever needed. Remember that deserts may become very cold at night. Prevent hypothermia and hyperthermia.
2. **Start each day with a nourishing meal and plenty of fluids.** Then, if you must face a crisis situation, your body will be better prepared to cope with it. Take plenty of fluids and nourishing food for snacks. Prevent dehydration.
3. **Take your survival kit.** It contains the makings for a shelter to combat hypothermia and hyperthermia, plus food and drink, to combat fatigue and dehydration.
4. **Take your first aid kit** to deal with injuries. Complete a first aid and CPR course and renew your training as required.

##### **13.1.2 Routines to Prevent Survival Situations**

Good communication, careful traversing, good judgement and awareness help prevent accidents and mishaps that lead to survival situations.

## Communications

- Give accurate details of your daily route and plans to your field leader each day. Leave grid coordinates, etc., if possible. Update your location throughout the day by pacing, air photos or other methods - don't just rely on your GPS or your best guess. Then, you can accurately communicate your location to others.
- Immediately relay any changes in plans or dangerous developments to base camp or your supervisor, e.g., impending bad weather or a vehicle breakdown. Always inform people of changes in your route or they may search in the wrong direction or in the wrong area.
- Use satellite phones in remote locations or cellular phones where you have access to a network. The importance of good communication in emergency situations cannot be overemphasized.

## Traversing

- Keep track of your location on your map as you traverse or you will become lost. **STOP** anytime you are not sure where you are. **STOP** if you discover you are not where you think you are. Back track, if necessary, to place yourself accurately on your map. Do not continue until you know where you are. If you are truly lost ... **STOP**.
- Know your field area. Before you start traverses, agree on targets to aim for if you become lost. Carry maps that extend beyond the boundaries of your area to help you locate yourself if you stray from your traverse.
- Look out for good emergency campsites or places to seek shelter as you traverse throughout the day. Be ready to quit work early in order to seek shelter or to make an emergency camp if conditions deteriorate. Don't wait until dark or until you are too tired to think clearly. Exhaustion leads to bad decision making.
- Always carry a fluorescent signal cloth 2-metres square. Wear brightly coloured clothing, especially when you work in brushy or forested areas, work from boats and during hunting season. You will be easier to locate from the air and less likely to be mistaken for game.

## Good Judgement and Awareness

- Make sure your vehicle is in good mechanical condition. Make sure it is properly equipped with first aid and survival kits and manuals. In some areas, field vehicles should be equipped with radios. Take plenty of extra food, extra water, fuel and clothing if you work in a harsh climate.
- Do not work too far from your vehicle in hot or cold weather as hyperthermia and hypothermia can set in quickly.
- In desert areas, you should carry water and your survival kit, including matches and a signal mirror, any time you leave your vehicle. Always carry extra water if you walk farther than 30 minutes from your vehicle. Avoid dehydration.
- Try to obtain the daily weather forecast. Heed any warnings of potential problems like major storms.

**Recognize when risks and problems are adding up. Work to reduce the risks that produce hypothermia hyperthermia dehydration and fatigue.**

## 13.2 PREPARATION TO CONFRONT A SURVIVAL SITUATION

### **You can best prepare for an emergency survival situation by**

1. Thorough planning and preparing for each day's traverse
2. Training to survive in various environments
3. Becoming familiar with the area where you will do field work.

Your survival depends on how you react in an emergency, the actions you take and how you adapt to new challenges as they arise. You need to prepare your mind to deal with possible crisis situations. Recognize that you will be challenged by stresses that may include many of the following: pain, cold, thirst, hunger, fatigue, fear, boredom, loneliness and group dynamics. This chapter deals extensively with methods to combat cold, heat and thirst. These, along with fatigue, can dull your mind so you cannot think clearly. When your mind is affected by these conditions, you may make poor decisions that will compromise your personal safety in an emergency situation.

### **Attitude - Knowledge - Equipment**

Experts claim that survival is 80% attitude, 10% knowledge (skills and equipment use) and 10% equipment. Therefore, a clear-thinking, innovative mind is your best ally in a survival situation.

### **Attitude**

You need a very positive attitude and a strong will to live when you face a survival crisis. You must think rationally so you can withstand the stresses that threaten your physical well being.

- **KEEP CALM. PANIC IS A KILLER.**
- If you are part of a group, you can avert panic through careful organization, good leadership and working as a team. Group dynamics can accentuate or reduce problems that include food, water, shelter or leadership issues.
- If you are alone, it may be more difficult to cope with the situation and to control the urge to panic. It is essential, however, to manage your emotions and assess the emergency situation quickly and correctly with a calm clear mind.
- In a stressful situation, the adrenaline flows and people's reactions change as they deal with a worsening situation. One can identify three levels of reaction that end with panic.
  1. **Concern** - It is easiest to think clearly at this stage.
  2. **Fear** - Do not deny fear; use it to direct your actions in a positive way.
  3. **Panic** - It is almost impossible to reverse panic once it starts.

Because panic often leads to death, you must control any urge to panic. A group leader must constructively focus the group to address their physical needs and keep the anxiety level at the stages of concern and/or fear. An individual must do the same for himself or herself. You must recognize fear and utilize it to direct your actions to meet your immediate requirements that will increase your chances of survival. People frequently die if they deny fear and refuse to admit the existence of danger. A small survival manual kept in your kit can be invaluable, as it will remind you how to tackle problems and which ones are most important to solve.

## **Prioritize problems and work to solve your most pressing ones.**

In order, these usually are

1. First Aid
2. Location
3. Shelter
4. Fire
5. Water and Food
6. Signalling for help

### **As time passes, you must continue to reassess your priorities. You must:**

- **Learn to improvise to solve problems.** If you lack something, find an alternative or create a substitute. Keep trying to solve your survival problems because success will probably not come on the first effort. Keep trying, because there are always things you can do that will make a difference and increase your chances of survival.
- Examples of creative ways to utilize parts of a plane after a crash are found in section 16.6. Some of these ideas can apply to using vehicle parts to create shelter, etc., in an emergency.

### **Knowledge**

- You must know how to prevent hypothermia, hyperthermia and dehydration.
- Learn and practice survival techniques. Learn how to construct emergency shelters that are appropriate for your area and how to obtain water, etc. Preparation and rehearsal will increase your self-confidence in a survival situation, which will help minimize fear that may develop and lead to panic.
- Survival equipment has limited value if you do not know how to use it. Learn how to maximize your chances of rescue. For example, know how to operate an aircraft ELT (Emergency Locator Transmitter) in addition to your basic skills with compass and signal mirror. Learn how to use transpiration bags and how to construct a solar still to collect water if you work in hot, arid climates.
- Learn bushcraft skills appropriate for your field area. Acquire knowledge of the local flora and fauna so YOU can safely use what is available in your environment in an emergency. This knowledge is very important in desert climates to help locate water.
- Understand the need to conserve your water. In arid places, including the Arctic, you must do everything possible to control the loss of your body's water. Learn how to avoid sweating (see To conserve your body fluids 16.5.5).

### **Equipment**

You need some basic, essential equipment to cope with a survival situation.

- Assemble your personal survival kit in a waterproof bag. It must contain items appropriate for your field area.
- Keep your kit on your body in a fanny pack or attached to your belt rather than in your pack, which may be lost in a capsizing or a helicopter crash. If this is not possible, keep the most essential items zipped in your pockets.
- It is your responsibility to take your survival kit with you every time a vehicle, aircraft, or boat drops you off. **Take your survival kit on every traverse and to each work site.** Do not send it ahead or leave it in a vehicle. Keep it with you so it is available, if you need it.

- If you work in the field only occasionally, you should still assemble and take a survival kit with you.
- **Keep survival supplies in your vehicle - enough for each passenger.**
- By law, all charter aircraft in Australia, Canada and the USA must carry survival equipment. Make sure it is on board for each flight and you know where it is stowed.
- If one is available for your region, include a small survival booklet in your survival kit. It will help you focus on the most important tasks if you face a crisis situation.

### 13.3 SURVIVAL EQUIPMENT LISTS

The contents of your kit and/or survival cache can vary depending on the season and your geographic location.

#### Suggested Items for a Personal Basic Survival Kit

Large brightly coloured, heavy-duty plastic garbage bags	Tin foil – for boiling water, signalling, etc. Fold or wrap it around something flat in your kit.
Matches – waterproof, or kept on a waterproof container, cigarette lighter	High-energy food packets, soup, cubes, tea bags, chocolate bars, dried fruits, etc.
Candle	Water purification tablets (follow instructions carefully)
Knife	Band-aids
Signal mirror	Fishing hooks and line
Space blanket	Mosquito head net (depending on region)
Whistle (use plastic in cold climates)	Small survival book – appropriate for your field area
Insect repellent	Small container for your kit (small heavy-duty plastic bag, small metal or Tupperware-type sandwich box). Use this to contain your kit. It serves as a water container. If it is metal, you can use it for boiling water.
Adhesive tape	
Nylon line – 15 metres brightly-coloured braided fishing cord	
Flares and flare gun	

#### Additional Items for a Personal Survival Kit

Wire saw	Solid fire starter cubes
1 – 3 space blankets	Aspirin
Water treatment filter	Light sticks
Length of plastic tubing for siphon	

## Survival Cache

Tent	Flares and flare gun
Sleeping bags – 1 per person	Signal cloth and mirror
Candles, waterproof matches and lighter	Fishing gear – hooks and line
Solid fire starter cubes	Extra batteries for radios
Primus stove and fuel (for regions with limited fuel supply)	First aid kit
Cooking pot	Extra clothing, appropriate for your region
Food supplies	Insect repellent
Axe, small cross-cut saw, knife	Insect head net, 1 per person (depending on region)
35 metres of nylon cord	

### 13.4 GENERAL ADVICE FOR SURVIVAL SITUATIONS

- If an accident occurs, assess the situation and, if possible, contact others for help before you attempt a rescue.
- **Remain at your destination or pick up point** if your transportation fails to arrive. Co-workers will know where to find you.
- If your vehicle becomes stuck or disabled - **REMAIN WITH YOUR VEHICLE**. This is most important. You are safer remaining with a well supplied vehicle than if you strike out alone. It can provide shelter from hot or cold climatic conditions. Furthermore, a vehicle is more visible from the air than a person. The only exception to this rule is if you break down in jungle terrain where your vehicle is not visible from the air. In this case, you might seek a clearing to signal for help if no road traffic is forthcoming.
- Only leave your stranded vehicle, crash site, pick-up point, etc., if conditions are too dangerous to remain. Then, travel only until you find a safe location for an emergency camp. Leave a complete windproof and weatherproof note to indicate your intentions. Write your message on a page from your field notebook and place it in a plastic sample bag. Place it in a location where it will be easily seen and use flagging tape to draw attention to it. The note should state your destination, route, time of departure and the date. Mark your trail as you proceed so rescuers can follow you.
- If you fall into water or capsize your boat or canoe, you must avoid hypothermia. Get into dry clothes and build a fire for warmth, if necessary. Follow the advice in cold water immersion hypothermia in *Illnesses Linked to Cold, Heat and Altitude or Watercraft*.
- You can use your watch set to standard time to roughly determine the North and South directions. This method is not very accurate within 23° of the equator.

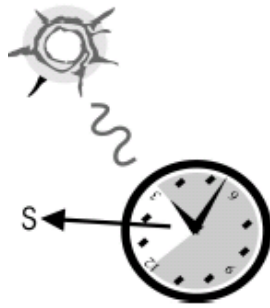

1. Northern Hemisphere

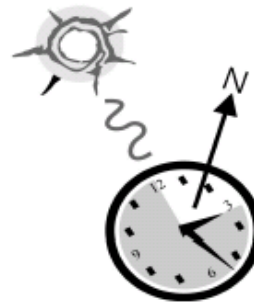

2. Southern Hemisphere

1. In the Northern Hemisphere, point the hour hand at the sun. South is located half way between the hour hand and the 12 on your watch-face.
2. In the Southern Hemisphere, point the 12 on your watch-face at the sun. North is located half way between the hour hand and the 12 on your watch-face.

Never try to walk back to base camp unless it is closer than 10 km and you are absolutely positive of the direction in which you must travel. You must:

1. Know where you are going and be able to set and maintain a course.
2. Be fit to travel.
3. Have sufficient supplies for the trip (clothing, water, food and shelter).

#### 13.4.1 Survival Advice for Cold Climate Conditions

- Know how to avoid hypothermia and other cold-related problems (*see* Illnesses Linked to Cold, Heat and Altitude 6.1).
- Always maintain your vehicle's fuel tank at least half full. This will allow you to run the engine intermittently to heat your vehicle's interior should you become stranded.
- You **MUST** ensure that the exhaust pipe is clear of snow or dirt to prevent asphyxiation when you use the engine to heat your vehicle. Leave a window slightly open for ventilation while the engine runs.
- Always tie a cord to yourself and the steering wheel or door handle if you must leave your vehicle during whiteout conditions.
- **You can create a tent within a vehicle using 3 space blankets.**
  1. Tape one edge of a blanket to the windshield. Bring the blanket over your head and behind your back.
  2. Tape a second blanket over the inside of the window and door on the windward side to create a wind screen.
  3. Spread another space blanket on the floor. Curl up on the seat inside the blankets.
- Use a coffee can candle, sterno "canned heat" or an emergency candle on the floor of your vehicle to generate heat once your fuel is gone. You can easily make one by filling a 1 kg coffee-can with wax and two wicks.
- If a group is stranded in a vehicle, you may be warmer if you huddle together. Coats spread out as blankets may provide the most warmth. Loosen any tight clothing.



## 13.5 PRIORITIES IN A SURVIVAL SITUATION

You advance your chances of survival if you recognize **immediately** when you are in a potential crisis situation and maximize every effort to help yourself. Consolidate your situation and attend to the following priorities. You will have the greatest energy level during the first three days, so use this to your advantage. By the fourth and fifth days depression frequently sets in and people lose their will to live and ability to think clearly at this time. If you survive these days, your attitude usually improves as you grow familiar with the situation. Only a very strong will to live and a positive mental attitude will pull you through. Prior planning and preparation will help you know what you are up against and allow you to respond appropriately.

You must meet the physical needs of a survival situation as quickly as possible. In a crisis, first check for injuries and attend to any necessary first aid. After this, **your priorities are location, shelter, fire, water/food and signalling for help** – usually in that order. In the case of an aircraft mishap, you should make certain that the aircraft ELT (Emergency Locator Transmitter) is transmitting a distress signal as soon as first aid is administered. **Take action in the following order of priority.**

### 13.5.1 First Aid

Administer first aid as necessary in a crisis situation. The injured need shelter as soon as possible. Try not to move them too far. Carry a miniature first aid booklet in your pack.

### 13.5.2 Location

- If you have radio contact, be sure to give a clear, accurate description of your position so that rescuers can find you more easily. If you know your location, you can utilize features in the area that may aid your survival. These may include water sources, safe shelter, etc.
- If you are completely lost, **STOP** and remain where you are. Proceed with the following priorities – do not waste energy wandering around. You must avoid exhaustion so you can think clearly. By continuing to wander, you might walk out of the search area.
- Choose a conspicuous place to shelter so rescuers can find you more easily.
- **Remember to remain with or very close to your transportation (vehicle, etc.).**

### 13.5.3 Shelter

You need to protect yourself from the climatic elements to avoid hyperthermia, hypothermia and dehydration. Use your ingenuity to remain as comfortable as possible without expending much energy. Allow enough daylight to build any necessary shelter. Always remember to insulate yourself from the ground by making a mat of boughs or grasses to rest on.

#### **Criteria for Shelter Sites**

- Remain with your transportation. Incorporate it or use it as shelter, if appropriate. Suspend plastic or space blankets, etc., from your vehicle, aircraft or boat.
- You need good water, fuel and shelter supplies – and a safe fire for warmth and signalling.
- Avoid building a shelter where there are obvious dangers such as wet overhanging branches or potential mudslides or rockslides. Also avoid low flood-prone areas and wet insect-infested areas.
- A hill may provide a breeze to relieve insect annoyance.
- In cold or wet weather it is vitally important that the shelter site and shelter protect you from the wind.

- In hot climates, find or create shade in an elevated place, as the temperature there will be lower than at ground level.

## Types of Shelters

You can construct simple shelters from a variety of materials.

### Lean-to Shelter

- This simple shelter can be constructed from a wide variety of materials and is adaptable to many environments. Build your lean-to only as long as your height so you do not waste energy heating extra space. Allow at least two hours of daylight to build a lean-to.

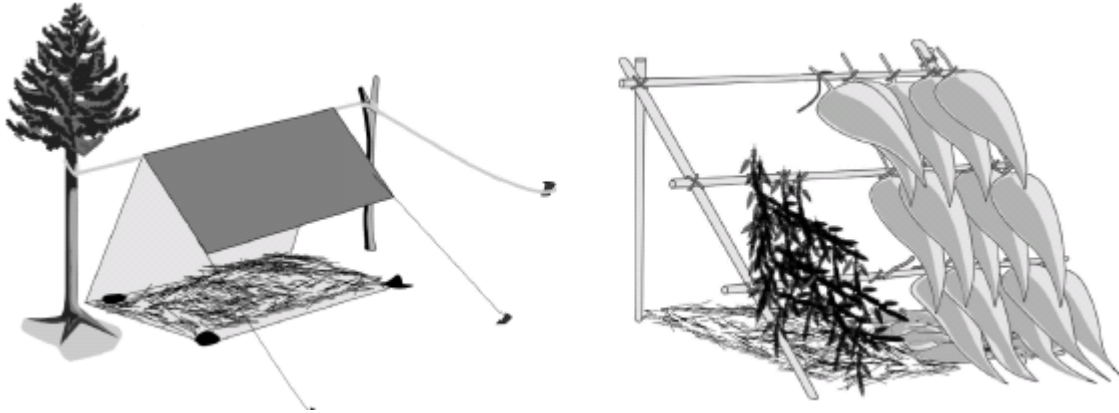

- For a simple lean-to, suspend a tarp between trees, cactus, bushes, etc., for a windbreak. Position it to protect yourself from the wind. Insulate beneath yourself.
- Build a framework from trees, sticks or tree branches – or even in combination with rocks. Make upright supports by using trees or two or three crossed, freestanding poles. These must support a ridge pole against which you lean more upright sticks at a 45° to 60° angle. This slope will allow rain to drain away efficiently. Place smaller sticks horizontally on these sticks to support the roofing material. Tie the components together using ropes, vines, grasses, shoelaces, etc.
- Roof coverings for a lean-to shelter can consist of a plastic tarpaulin, evergreen branches, bark, palm leaves, split bamboo stems or whatever is available in your environment. Build up vegetation in layers from bottom to top as though shingling a roof.
- Make sure that the layers of evergreen branches are at least 15 cm (6 inches) thick so that rain does not penetrate. If there are heavy rains or winds, use your plastic covering on top of the branches.
- Thick bark (split bamboo in the tropics) can be laid like pan tiles. Make a gutter from these to drain water away. The roof need not extend to the ground in a warm climate where ventilation is desirable.
- Stuff the ends of the lean-to with vegetation to stop winds. Insulate beneath yourself.
- Build a long fire at the opening of the lean-to. Do not build two lean-tos facing each other with a fire between, as one shelter will fill with smoke.

### Plastic garbage bag tube shelter

- Two large plastic garbage bags (opened at the ends and taped together to form a tube) can provide you with shade or immediate shelter from water and wind.

- Crawl inside the tube or suspend it to make a tent. Use a rope or stick to prop up one end. Anchor the edges to the ground with rocks, bark or vegetation. Insulate beneath yourself.
- These bags are an essential part of your survival kit. Use fluorescent or bright orange garbage bags for high visibility and signalling.

### Other simple shelters

- Use an overturned canoe or inflatable boat as the foundation of an emergency shelter. Insulate beneath yourself.
- Use a fallen tree as the foundation of a lean-to shelter. Insulate beneath yourself.

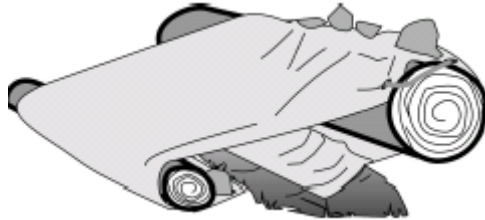

- Use **two adjacent logs of unequal size with a plastic sheet stretched over them** for shelter with drainage. Or, use **mounds of sand or rocks** to support and control the placement of your space blanket. Scoop out dirt between the logs and insulate.

### Cold Climate Shelters

Shelters carved from snow are relatively quick to make. Keep the shelter space small – not much bigger than your body. It can be surprisingly warm if you have a small source of heat. If you block the entrance to retain warmth, you must create an air hole to avoid asphyxiation. **Always remember to insulate beneath yourself.**



**Tree base shelter.** Dig out accumulated snow near the trunk of an evergreen tree with spreading branches. Use the space beneath low branches for shelter. Insulate.



**Quin-zhee (Create your own cave).** Sometimes, only powder snow or very little snow is available. In this situation, you can scrape the snow into a mound and let it settle for several hours. The snow must recrystallize so the snow particles bond together. Dig out a small tunnel for shelter. The walls must be at least 30 cm (1 foot) thick. Insulate and leave an air hole at the entrance. This is a lot of work, but it provides you with shelter.



**Snow tunnel.** Dig out a tunnel in a snowdrift and insulate the floor surface. Leave an air hole at the entrance.



**Snow cave.** Dig out a small cave in a snowdrift. Create a raised sitting or sleeping platform. Insulate the platform and make an air hole for ventilation.

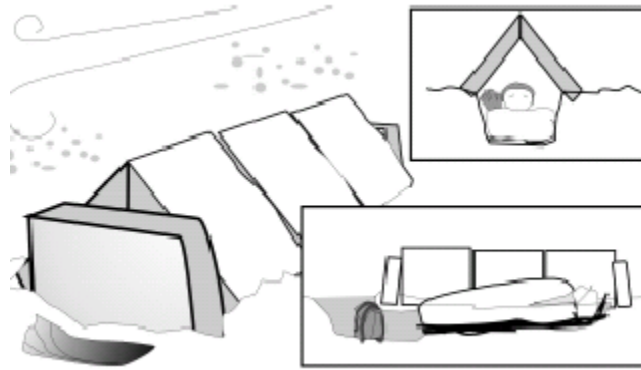

**Snow or fighter trench.** Uniform slabs of snow can be excavated and stacked at a 45° angle over the trench from which they were cut. The trench should be slightly longer than your height and wide enough to accommodate your sleeping bag and insulation. Avoid this form of shelter if you do not have a sleeping bag as it will become a cold tomb. Dig a snow cave or a Quin-zhee instead.

#### 13.5.4 Fire

Fire provides warmth. With fire, you may boil water for drinking and dry your wet clothing, etc. It lifts your spirits if you are in a survival situation. Make your fire only as large as necessary so you don't waste energy collecting extra fuel. Try to place your fire where rescuers can see it.

- Always carry plenty of matches in a waterproof container and fire lighting materials in your pocket.
- Choose a safe place to build a fire. Clear a large circle and scrape down to bare mineral soil. Don't build a fire on moss, needles or roots, etc. Make certain no overhead branches will catch fire or drop snow on your fire and extinguish it.
- Avoid using "river rocks" around the perimeter or as a foundation for a fire, as they may retain moisture and explode when heated.



- In wet areas or on snow, build a platform of green wood and cover it with earth, if possible. In flooded areas, raise this platform on stilts. Build your fire on this platform.

**Assemble everything before lighting the fire.** All your fuel should be within reach. Have water available to extinguish the fire.

- **Ignition to start a fire.** In addition to waterproof matches or a cigarette lighter, spark-producing materials include a magnifying glass, vehicle batteries and several chemicals.
  1. Focus strong sunlight through a magnifying glass or a camera lens to produce heat to generate fire in the tinder.

2. Use two pieces of wire and connect one to each terminal of the battery. Touch the free ends of the wires together next to your tinder. It is safest to use long pieces of wire and to remove the battery from the vehicle. **Warning:** The battery may explode, especially if you use metal tools (spanners, knives, etc.) in place of wire. Do not allow the wires to touch any other metal such as the vehicle frame or a short circuit may occur. Torch (flashlight) or radio batteries may have enough power to produce a spark.
- **Tinder** must be dry. Use bits of cotton lint, pitch, fir cones, moss, shredded dry bark, powdered wood from insect borings or fluff from plants, etc. These catch fire quickly and they can be soaked in fuel oil if this is available.
  - **Kindling** should catch the flame from tinder. Use small twigs, dead leaves or grass, shaved wood bits, inner bark of dead trees, etc.
  - **Fuel.** Start with dry wood. Add fuel slowly so the fire does not smother. Green or wet wood burns slower and creates smoke which helps keep insects away. Mixing dry and wet wood helps a fire last longer.

### **Fires in the Arctic**

- Wood for fuel is rare in the Arctic. This means you must carry your own fuel and stoves or you must improvise.
- Kerosene or diesel fuel can be drained from aircraft, vehicles or drums and burned. You can use rags soaked in fuel for a fire. Fill cans with dirt or sand and then soak with fuel. These may be set alight and contain a fire.
- Take care not to cause a tundra fire.

### **13.5.5 Water and Food**

Water is more important to your survival than food. You can live a month without food, but only a few days without water. If you work in areas where water is usually not safe to drink, carry water purification equipment (e.g., tablets, filter or a container for boiling). Remember that dehydration can be a serious problem in the Arctic. Never travel in desert terrain without sufficient water for everyone, extra water for emergencies and equipment to obtain water. Each person needs 10 litres (2.5 gallons) a day when working in hot climates. If you become stranded, stop work and make every effort to conserve the drinking water you possess as well as the water within your body. Do everything you can to prevent the formation and evaporation of sweat. It is better to “ration your sweat, not your drinking water”. **Do not reduce your water intake in the first 24 hours of a survival situation because dehydration impairs your ability to think clearly.**

#### **To conserve your body fluids:**

- Make every effort to avoid sweating, crying or vomiting. Do not eat anything that might cause diarrhea.
- Drink sufficient water frequently enough to quench your thirst. Don't just sip small amounts; you must drink enough to avoid dehydration.
- Follow the guidelines in this chapter for clothing, rest and shelter.

#### **Sources of Water**

- Surface sources such as lakes, streams, pools or watering holes may or may not provide clean safe water. They may contain viruses, bacteria, and numerous parasites including flukes, leeches, etc. Filter any muddy or scummy water through a handkerchief if you do

not have a proper filter. Let it settle, then purify it by boiling or chemical treatment, if possible.

- If you cannot remove surface water to filter it, you can lay a handkerchief on the surface and sip the water through the cloth.
- Sop up dew from vegetation or the surfaces of trees, vehicles, rocks, etc.
- When you search for sites to dig for ground water, look for areas where plants that require water are growing. In Australia, look for greasewood, casurinas and baobabs. Typical plants in temperate areas would include willow, rushes, cattails and cottonwoods.
- Melted ice yields more drinking water than snow. Never eat snow as it lowers your core body temperature. If you lack a source of heat, squeeze snow in your hand to liquefy it.
- If it rains, spread out your plastic sheets, rain gear, extra clothing, etc., to catch it. Remember not to wet clothing that you need to wear for warmth. Depending on your situation, hypothermia may be a greater threat than thirst.
- Learn which plants in your work area will yield water and how to retrieve it. Some vines yield water when cut and held vertically. Some plants are easily chewed to release water.
- Never drink water from plants with milky sap or sap that turns black if exposed to air.

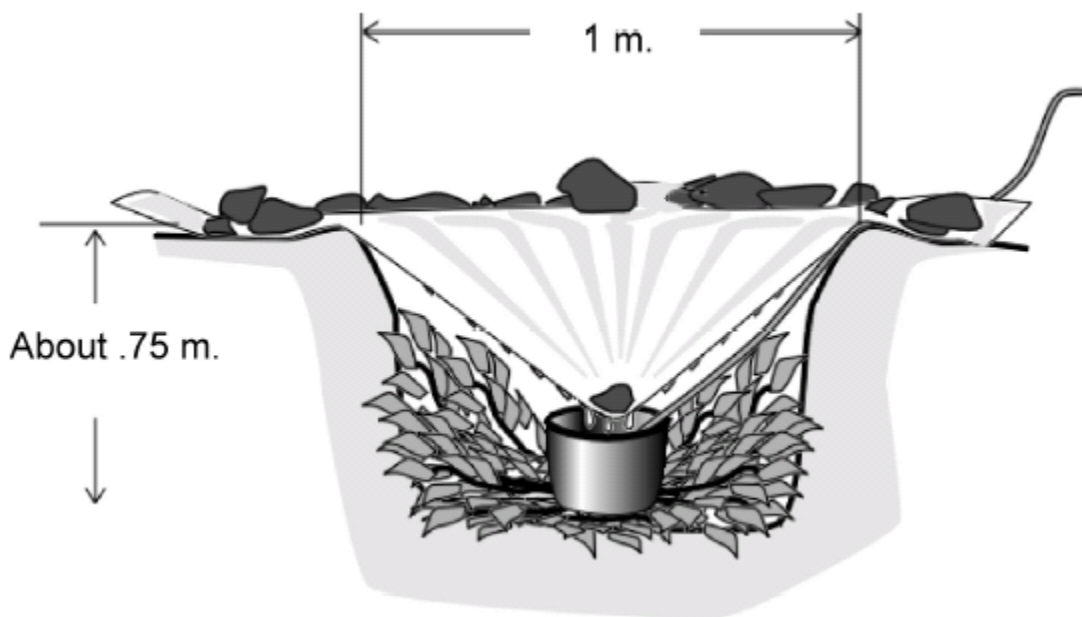

- You can obtain water by distillation by digging a **solar still**. The best site to make a solar still is where the earth is damp and easy to dig, although dampness is not necessary. Dig a new one when the still no longer produces water.
  1. Dig a hole .75 to 1 metre (3 feet) deep and .75 to 1 metre wide. The sides should slope so they do not cave in.
  2. Place a container in the bottom and cover the hole with clear or white plastic.
  3. Anchor the plastic around the edge of the hole and weigh it down with a stone to form a cone (about .5 metre deep) over the container.
  4. As the air warms within the still, the water from the ground will condense on the underside of the plastic and drip down into the container. You can insert a piece of tubing

so you can sip the water without disturbing the still. You can add cut vegetation and urine to the hole to provide additional moisture for distillation.

### **Sources of food**

- If you carry freeze-dried food packets and cans of sardines, etc., in your pack, you will have better nourishment than what chocolate bars provide.
- Use any food supplies that are already open as they will spoil first.
- Try to consume protein foods first because they require water to digest. Save your carbohydrate foods for later, as they produce water within your body during digestion.
- **Do not eat anything if you have no water available at all.** Most foods require water to aid digestion. You can live far longer without food than without water.
- Eat native plants only if you are certain that they are not poisonous. In general, avoid any with red, yellow or white berries; those with milky sap; stinging, bitter or acidic tasting plants; and fungi. If in doubt – do not eat it.

**Clean and wash all food sources**, if possible. Make sure they are as fresh as possible as toxins occasionally develop as plants age. Cook all gathered foods so that you have less chance of getting sick. Vomiting and diarrhea, even in cold weather, can quickly cause dehydration that may progress to death.

### **13.5.6 Signalling**

To be noticed, signals must stand out against the existing background and look man-made. As the target of a search, you should make yourself as visible and noticeable as possible – if you are able to do so.

- Consider what signals will stand out best given the season, the weather and the light conditions. Employ any and all possible methods that are safe and appropriate.
- Three of a signal indicates an emergency (e.g., fires, blasts of a whistle, flashes from a mirror, flashes of headlights).
- **Proper use of a signal mirror is the most effective way to attract attention as it can be seen for many miles.** Red flares can be seen for only a short distance.
- Do not set off an EPIRB (Emergency Position Indicator Radio Beacon) locator that ties in with search and rescue unless you are in a life and death emergency situation. An inconvenient night out in the bush does not constitute a reason to activate an EPIRB.

### **Aircraft Emergency Locator Transmitters – ELTs**

All aircraft should be equipped with an Emergency Locator Transmitter (ELT). In most countries, an ELT is mandatory equipment on any aircraft. This device automatically broadcasts a distinct signal on an internationally monitored distress frequency when an aircraft is involved in a crash. ELTs have a manual switch for testing purposes and manual emergency use. ELTs should transmit a signal for 48 hours at -20° C, if the batteries are properly maintained.

- Pilots should show passengers where the ELT is located before flights. All field employees should know how to activate an ELT in case it fails to engage after an emergency landing.
- Some ELTs can be removed from an aircraft. To broadcast a signal with the best range, place the ELT as high as possible so that it has a 360° range. For example, remove it from a



valley or the base of a cliff and place it on a hilltop or at the top of the cliff. Always make sure the ELT is connected to an antenna, which is in the vertical position.

- If you are forced down and no emergency exists (e.g., bad weather), **DO NOT** activate your ELT. Notify your field camp and anyone in charge of your flight plan or itinerary, or an aircraft passing overhead of your situation. This will prevent an unnecessary search and rescue effort. If you cannot contact any of these parties, a search will begin at the agreed upon time in your standard operating procedures. At this time, when the search begins, turn on your ELT to help rescuers locate you.
- Once started, an ELT signal should not be turned off. Search and rescue efforts need to receive the signal continuously to home in on it.

### Signalling with a mirror

**Always carry your signal mirror.** The flash of a mirror or other shiny surface (piece of tin, a can lid) can be used as a mirror and can be seen for miles, even in dull weather. Therefore, it is usually the most effective signal. Catching the sun's reflection and casting it onto a target is quite easy when the sun is high in the sky. It can be difficult to do when the sun is low. Practice helps. Signalling can be done with a Brunton or Silva compass mirror. If necessary, improvise with a can lid, aluminum foil, a chrome piece or the side or rear-view mirror from a truck. Use three quick flashes to signal an emergency. Repeat them, but **DO NOT** sustain a flash signal onto a nearby plane or landing aircraft as the signal may momentarily blind the pilot.

#### To use a signal mirror:

1. Hold a mirror under your sighting eye.
2. Extend your arm outwards and form a "V" with two fingers.
3. Sight the aircraft or object in the point of the "V".
4. Tilt the mirror under your eye so the sun's reflection also passes through the "V" in the direction of the aircraft.  
Flash the reflection on your target.



### Signalling with fire and smoke

- Fire is most visible at night and in low light conditions. Smoke is most visible during daylight.
- Where possible, make three fires a minimum of 30 metres (100 feet) apart to form a triangle. Fires in a straight line are acceptable along a river or restricted area. One good fire is better than three small ones.
- Have signal fires prepared, but unlit, so you do not waste fuel and energy to keep them going. Light them when you hear a plane. Keep smoke-producing material near each fire to add to the fire when required.
- You can set an isolated tree (torch tree) on fire by building a fire in the lower branches of it. Light it when you see or hear a plane. Make very sure that you will not start a brush or forest fire.

- To produce smoke, add ferns, green leafy branches, green leaves, wet magazines, moss, rubber tires or diesel fuel (carefully) to a fire. Puncture tires to prevent an explosion.

### 13.6 IMPROVISATION AS A SURVIVAL STRATEGY

While one of the many challenges when facing a survival situation is the limited resources to work with, people usually have more to work with than they realize. Some of the following suggestions might be adaptable for use with vehicle parts. Ingenuity helps create solutions to problems. If you lack something, find an alternative or create a substitute. If one approach fails, try again using the same or a different method. Keep trying, because there are always things you can do that will make a difference and increase your chances of survival.

It is important to remember, however, that following an aircraft accident, survivors must concern themselves with their ongoing safety and avoid additional injury from the surrounding hazards. Many aircraft components are assembled under high tensile or compressive pre-loading stresses. These components can become unstable when damaged and have the potential to cause serious injury if attempts are made to dismantle them. Such items include high pressure wheel assemblies, landing gear components, engine components, pressure accumulators, oxygen bottles and propellers. Fuel is a major fire hazard, particularly if engines are still hot or electrical shorting is present. Fuel and battery acid can cause skin and eye damage. Other hazards include sharp or jagged metal, perspex and glass, and broken wire cable strands.

To illustrate how available materials can be ingeniously used in a survival situation, a list of possible survival “tools” and materials found on an aircraft is given below. To minimize exposure to these hazards, avoid unnecessary dismantling of any components or structure. First try to use those items that may have broken off or are easy to remove, such as the interior cabin lining. In remote areas it may be some time before you are rescued so use what is available carefully to avoid further injury.

*Adamera Minerals thanks Doug Geeting for permission to reproduce the following list from his book, “Mountain Flying.”*

**Ailerons** – snow-cutting tools; shelter braces; splints

**Air Filter** – fire starter material; water filter

**Aluminum Skin** – reflector for warmth around a fire; signalling device; snow saw blade

**Battery** – signalling with lights; fire starter

**Brake Fluid** – fire starter

**Charts and Maps** – stuff inside clothing for insulation

**Compass** – oil for starting fire; direction finding

**Control Cables** – rope; snare wire; binding for shelter

**Control Pulleys with Cable** – block and tackle

**Disk Brake Plates** – signalling device

**Doors** – shelter; windbreak

**Engine Cowls** – shelter; water collector; windbreak; fire platform

**Engine Mags** – spark producers for starting fires

**Engine Oil** – fire starter; black smoke for signalling

**Engine Gas** – fire starter; fuel for stove; signalling

**Fabric Skin** – fire starter; water collector

**Fuel Cells** – use to melt snow on a black surface; black smoke for signalling; place on snow for signal to search-and-rescue planes

**Fuselage** – shelter

**Hoses** – siphon for water/gas/oil; burn for black smoke

**Inner Tubes** – canteen; elastic binding; black smoke signal

**Interior Fabric** – water strainer or filter; clothing; insulation; bandages

**Landing Light Lens** – fire starter

**Landing Light, Strobes** – use with battery to signal at night  
**Light Covers** – utensils; small tools  
**Magnesium Wheels** – signalling devices  
**Nose Spinner Cone** – bucket; stove with sand, oil and fuel; scooping tool; cooking pot; funnel  
**Oil Filter** – burn for black smoke  
**Propeller** – shovel; snow-cutting tool; shelter brace  
**Rotating Beacon Lens** – drinking cup  
**Rugs** – ground pad; insulation; clothing  
**Seats**– sleeping cushions; back brace; fire starter; signal material; insulation; ground pad; rubber sponge for neck support  
**Seat belts** – binding material; slings; bandages  
**Spring Steel Landing Gear** – pry bar; splint  
**Tires** – fire starter; fuel; black smoke  
**Vertical Stabilizer** – shelter support; platform  
**Wheel Fairing** – water storage; water collection; black smoke  
**Windows** – shelter; windbreaks; cutting tools  
**Wings** – windbreaks; shelter supports; overhead shade; platform for fire; water collector; signalling device; crutch  
**Wingtips** – drip collectors; water carriers  
**Wiring** – binding; rope  
**Wooden Wing Struts, Braces, Props** – fire starter; fuel; pry bar; splint; shelter brace; flag pole

## **EMERGENCY RESPONSE PROCEDURES FOR SURVIVAL**

### **INCIDENT: STRANDED DRILL CREW DUE TO HELICOPTER PROBLEMS OR SEVERE WEATHER**

- 1. CONTACT THE CAMP OFFICE BY RADIO EITHER DIRECTLY OR VIA THE HELICOPTER**
- 2. DETERMINE WHETHER PARTY IS ABLE TO SAFELY RETURN TO CAMP BY FOOT. THIS SHOULD BE ONLY CONTEMPLATED IF THE PARTY KNOWS THE LOCATION OF CAMP AND IS REASONABLY CLOSE TO CAMP, IF WEATHER CONDITIONS ARE GOOD, GPS EQUIPMENT IS FUNCTIONING, AND SUPPLIES FOR THE JOURNEY ARE PRESENT**
- 3. WHERE IT IS NOT FEASIBLE TO RETURN TO CAMP, THE DRILL EMERGENCY SHELTER WILL PROVIDE TEMPORARY SHELTER AND SUPPLIES IN THE CASE OF A WHITEOUT, THE CREW SHALL REMAIN AT THE SHELTER**
- 4. STAY AT SHELTER SITE UNTIL HELICOPTER ARRIVES**
- 5. ENSURE THE ABILITY TO COMMUNICATE BY RADIO IS MAINTAINED**

#### **OTHER CONTACTS ARE**

*Office or Expeditor 604-689-2010 (Office) / 867-920-4600 (Discovery Mining Services)*

**OR**

*Aircraft Office at (867) 669-8218 (Air Tindi)*

**Or** (867) 873-4464 (Arctic Sunwest Charters)

## **14. DRILL SITE PROTOCOL**

Only properly trained contact drill personnel are to operate drill equipment.

### **Visitors to the drill sites must observe the following precautions and procedures:**

- Handle equipment of machinery only if you have been trained for the job.
- Wear a hard hat, hearing protection, steel toed boots and any other personal protective equipment as directed by the drill crew supervisor.
- Stay clear of the drill if it is running.
- Be vigilant and do not stand nearby when drillers are changing rods. They sometimes fall from the mast.
- Do not wear loose clothing or jewelry that might catch in machinery (including rings).
- Wear respiratory masks when you work in or visit dust areas.
- Beware of slippery, wet or greasy floors in drill shacks.
- Do not lick drill core samples. Chemical residues left by drilling fluids may be poisonous. Use another source of water to examine a sample.

## **15. DRILLING**

### **15.1 RESPONSIBILITIES**

### **15.2 DRILL SITE LOCATION, PLANNING AND PREPARATION**

### **15.3 ESSENTIAL SAFETY PROCEDURES**

- 15.3.1 Emergency Response Plans (ERPs)
- 15.3.2 Communications
- 15.3.3 Pre-program Safety Meeting
- 15.3.4 Accident Reporting
- 15.3.5 Safety Inspections
- 15.3.6 Personnel Conduct
- 15.3.7 Site Visitors

### **15.4 OPERATIONAL SAFETY**

- 15.4.1 General Safety Issues
- 15.4.2 Personal Protective Equipment (PPE)
- 15.4.3 Housekeeping
- 15.4.4 Manual Handling

### **15.5 COMMON TYPES OF DRILLING INJURIES**

### **15.6 HAZARDS LINKED WITH SPECIFIC EQUIPMENT**

- 15.6.1 Pressure Hazards
  - 15.6.1.1 Compressed Air Systems
  - 15.6.1.2 Hydraulic Systems.
  - 15.6.1.3 High Pressure Pumping Systems.
- 15.6.2 Mechanical Hazards
  - 15.6.2.1 Rotating Drill Rods
  - 15.6.2.2 Exposed Machine Parts
  - 15.6.2.3 Entanglement (“Pinch Points” or “Nip Points”)
  - 15.6.2.4 Mechanical Failures

### **15.7 HAZARDOUS SUBSTANCES**

- 15.7.1 Dust
- 15.7.2 Other Hazardous Substances

### **15.8 FIRE**

### **15.9 HEALTH**

- 15.9.1 Noise
- 15.9.2 General Health Issues

Adamera employees who work at drill sites face exposure to hazards associated with drilling equipment and sampling processes. Contractors working at Adamera drill sites must comply with all relevant sections of the Insurance Terms in Exploration Contracts. This chapter covers safe work procedures associated with the common hazards, risks and danger zones of various drilling methods.

**Accident prevention at drill sites depends upon planning and preparation in three areas:**

1. Ensure that drilling contractors apply the highest possible safety standards.
  2. Ensure that Adamera drill site personnel (e.g., geologists, samplers, visitors) are informed and understand the potential hazards and risks.
  3. Ensure project managers have sufficiently detailed technical knowledge of drilling to effectively manage drilling projects and monitor contractor's safety compliance.
- ❖ This symbol indicates extreme safety importance to Adamera drill site employees such as samplers and geologists.

## **15.1 RESPONSIBILITIES**

Drill site safety must be a joint effort between contractors and Adamera.

**Adamera will use contractors with good reputations for performance, safety and environmental responsibility.**

- The project manager must clearly communicate with the drill contractor so the contractor is familiar with all the potential hazards and risks of the drill site. If possible, the drill contractor should visit the site prior to set up.
- The project manager must consult with the drilling contractor prior to drill site preparations to determine the minimum size, shape and preferred working layout of the site for personnel, drilling equipment and vehicles and/or aircraft.
- The on-site drilling supervisor must be able to communicate clearly in the required language(s) with all drill site personnel so that instructions, requirements, safe work procedures, etc., are fully understood.
- The project manager must ensure the drilling contractor applies the highest possible safety standards.
- The project manager must ensure that all employees and visitors are informed and understand the potential hazards and risks at the drill site.

## **15.2 DRILL SITE LOCATION, PLANNING AND PREPARATION**

Carefully plan the site layout to minimize natural and man-made hazards that contribute to accidents. Minimize environmental disturbance.

- For addressing camp location, set up and fire hazards.
- Address site problems such as manual handling, confined working space, the need for special platforms for steep terrain, guard barriers to prevent falls into old open mine works, adequate access and parking space for service vehicles and equipment, aircraft, etc.
- Plan the site layout for clear escape routes from all areas in case of emergency (e.g., fire).

- **Power lines, underground utility cables and pipe lines.** If it is necessary to drill near these hazards, notify the appropriate authorities and use extreme caution while drilling. Where no regulations exist, apply a minimum of 20 metres distance setback from all power lines.
- **Old mine sites and chemical hazards.** Watch out for possible unidentified or unmapped raises and stopes, old machinery or rails, rotting wood from supports, etc. Watch out for dumps that may contain toxic materials, etc.
- Drills sometimes operate in urban areas with only one shift during the day because of noise restrictions. Guards or caretakers should be appointed to look after the drill during the night
- Where sumps are required, ensure they are of sufficient volume to contain all circulation fluids. Calculate the volume from the depth and diameter of the proposed hole.
- Locate the sample and core viewing areas (core shack) well clear of operating machinery, cyclones and high pressure hoses.
- If it is necessary to construct drill pads on steep slopes using “cut and fill” methods, do not locate drilling equipment on the area of fill until it is properly compacted and sufficient drainage is in place.
- If the potential exists to encounter high-pressure gas and water particularly when drilling, the contractor must be informed and instructed to use blow-out protection on the drilling equipment.
- When drilling in some sedimentary terrain, potential for encountering poisonous or flammable gases such as H<sub>2</sub>S or methane may exist and appropriate equipment such as gas detectors, masks etc., must be available at the drill site.
- **Other hazards** may include extreme climate and/or terrain (Arctic, desert or mountainous regions), wildlife (e.g., venomous snakes, insects, bears) and cultural, language or security issues.

### 15.3 **ESSENTIAL SAFETY PROCEDURES**

#### 15.3.1 **Emergency Response Plans (ERPs)**

- Prepare an ERP for the drilling project at the start of drill operations and send a copy to the regional office. All on-site employees must be familiar with this plan.
- Ensure that suitable and well maintained first aid kits, fire extinguishers and any necessary spill containment kits are properly located. On-site personnel must be trained to use the emergency equipment.

#### 15.3.2 **Communications**

Establish and maintain a regular communication schedule between the drill site and base of operations or office.

- Maintain communication equipment in good repair and ensure it works properly.
- Communications for information about types of communication equipment, general and emergency procedures and contact numbers.

#### 15.3.3. **Pre-program Safety Meeting**

- ❖ **Hold a detailed safety meeting for all employees at the start of a drilling program.** It is most effective to hold this meeting at the drill rig. This ensures that all drill site personnel



understand the potential hazards, the safety rules that apply and the responsibility for their own safety and for the safety of others.

- At the meeting, ask the contractors' drilling supervisor or senior driller to physically point out each of the “Danger Zones” and known hazards around the drill. The hazards are not always obvious to Adamera personnel.

#### **15.3.4. Accident Reporting**

- Report all accidents or incidents to Adamera site representative within 24 hours. Contractors must provide a written copy of an accident/incident report to Adamera as soon as possible (a verbal report must be made within 24 hours).
- Investigate all accidents and incidents promptly. Immediately implement safe operating procedures that stem from the investigation of any injury or safety incident to prevent recurrence. The drilling operation must not re-commence until the site and/or equipment is made safe.

#### **15.3.5 Safety Inspections**

- Conduct a drill site safety inspection at the start of each drilling program and at regular intervals during long programs.
- Safety inspections should include the drill rig, vehicles, drill site, procedures, methods of operations, etc. Both Adamera and contractor personnel should participate in all inspections.

#### **15.3.6 Personnel Conduct**

**Employees must behave responsibly at all times at the drill site.**

- Walk – never run – in drilling and work areas. Haste contributes to many accidents.
- Never throw objects in the drilling or work area. Hand them to your co-worker or set them in their correct place.
- Do not distract your co-worker while he or she is concentrating on a job.
- Operating machinery or vehicles under the influence of alcohol or deleterious drugs are grounds for dismissal.
- Employees may only use fire fighting equipment, water hoses, compressed air hoses, electrical tools, hand tools, etc., for the correct and intended use. Such equipment must never be used for pranks or practical jokes.
- Horseplay will not be tolerated around operating drilling machinery. Fighting will not be tolerated at any time. These activities are grounds for dismissal.
- **All employees and contractors must adhere to Adamera’s guidelines or policies related to the use of firearms.**

### 15.3.7 Site Visitors

- Visitors to drill sites must receive a safety orientation to review the on-site hazards. Alert visitors to all “**Danger Zones**” around the drill rig. Ensure visitors understand and observe the “**Keep Clear Principle**” for all operating machinery. A trained and experienced employee must accompany all visitors if they must approach operating machinery (*see* 20.4.1).
- No visitors may visit the drill site without a work-related reason.
- All drill site visitors must wear the required Personal Protection Equipment (PPE).
- Visitors may view samples and core **only** in an area well clear of operating machinery, cyclones and high pressure water or air hoses.
- Visitors must park any vehicles well clear of the drill site.
- Family and friends of on-site employees may not visit the site without the express permission of the on-site Adamera representative.

## 15.4 OPERATIONAL SAFETY

### 15.4.1 General Safety Issues

- ❖ **Danger Zones.** Adamera declares a “**Danger Zone**” around all hazardous areas of equipment and machinery at a drill site. Danger zones include all compressors and high pressure air hoses, sample discharge hoses, high pressure pumps, rotating drill rods, unguarded machinery and whenever drill rods are being handled or hoisted. (*see* Figures 4 and 5). All employees and visitors must be made aware of them. Discuss and point out all danger zones during the pre-program safety meeting at the drill and again whenever circumstances indicate a review is necessary. **NO ONE may enter a danger zone without a work-related reason.**
- ❖ **Keep Clear Principle.** Everyone - drilling employees, Adamera employees and visitors must keep clear of hazardous areas and operating machinery at the drill site unless they have a work-related reason to be in that place.
- ❖ Do not distract or speak with the drill operator during rod changes and while the drill rods are rotating. If you must talk to the drill operator, ensure that you catch sight of the driller before approaching – don’t surprise him or her. Approach from a direction that eliminates the need to cross in front of rotating drill rods, which is especially important when drilling inclined holes.
- ❖ **All non drill crew personnel must stand well clear of the drill during rod handling, rod hoisting and when rods are being connected or disconnected.**
- ❖ Adamera employees are **not authorized** to operate, drive, climb, work on, repair or service a contractor’s drill rig, vehicles or equipment.
- ❖ Core saw operators are required to wear a full-face shield or safety glasses and hearing protection. As core saws use water to wet down the silica dust generated from the cutting procedure, a waterproof apron, gloves and steel-toed rubber work boots may also be required. If core saws are operated in a confined area, enough silica dust may become airborne to create hazardous breathing conditions. Consult the regional safety coordinator about the need for extraction ventilation equipment at the core saw operation site and for required respiratory protection. It may be necessary to use a dust mask – even a respirator.

- Employees may not travel in the back of flat bed, pick up or trayback vehicles unless properly restrained.
- If a lightning storm threatens, shut the drill down and move all personnel to a safe location because the drill mast may act as a lightning rod. Lower the drill mast if time permits.
- Beware of electrical hazards and follow safe procedures when operating electrical equipment. Do not take short cuts with electrical wiring, etc., just because a drill site is a temporary location.

#### 15.4.2 Personal Protective Equipment (PPE)

**Specific safety rules regarding PPE apply to all drill sites. Signs must be displayed to indicate all mandatory PPE.**

- ❖ All personnel within 30 metres (100 feet) of an operating drill must wear and use all required PPE. This includes hard hats, steel-toed boots, safety glasses and hearing protection. For some types of work, additional PPE may be required, e.g., gloves, full-face shield, dust masks or respirators, correct fall protection or special protective clothing.
- ❖ Inspect PPE frequently and maintain all PPE in clean, good working condition. Select PPE carefully – if it fits poorly or is uncomfortable, it may not function correctly. Replace damaged PPE.
- **Head protection.** Hard hats must be government approved. Use add-on sun brims for hard hats in very sunny locations.
- **Foot protection.** Safety boots should be sturdy and have steel-capped toes.
- **Eye protection.** Approved safety glasses must be worn at all times by all personnel at the drill site. Combination sun/safety glasses may help promote the use of eye protection.
- **Ear protection.** Wear correctly fitted earplugs and/or earmuffs at all times whenever the drill rig is operating. Use ear protection that is correctly rated for the noise level of the drill rig. The risk depends on the intensity of noise and length of exposure. While most cases of industrial deafness are due to years of exposure to high noise levels, hearing may be permanently damaged by exposure to very high noise levels for relatively short periods. **Do not neglect to wear auditory PPE.**
- ❖ **Respiratory protection.** Wear suitable respiratory protection in the vicinity of any drill using compressed air as the circulation medium or when processing dry samples. Use respiratory protection when working in dusty sample preparation conditions. Project managers should seek advice about respiratory protection from the regional safety coordinator. While dust masks may provide acceptable protection, certain working conditions may require a respirator. For example, disposable filtertype dust masks do not provide adequate protection in the presence of high concentrations of high risk atmospheric contaminants such as silica, asbestos or coal dust. **Do not neglect to wear respiratory PPE.**
- ❖ **Gloves.** Gloves help reduce hand injuries, the most common type of injury at drill sites. Drillers should wear close-fitting gloves when handling drill rods, winch cables, ropes, etc. Everyone should wear gloves to handle core trays and chemicals, etc.
- ❖ **Fall protection.** A full body harness and shock-absorbing lanyard is mandatory when working on the drill mast.
- **Clothing.** All drill crew members and employees should wear suitable work clothing. **Never wear loose clothing that may catch in machinery.**

### 15.4.3 Housekeeping

Good housekeeping reduces the risk of trips, slips, falls, sprains, cuts and more serious accidents.

- Keep access ways and passages within the site tidy and free of gear and equipment, etc. Allow ample space for easy movement of personnel and drilling supplies around the site.
- Keep walkways free of grease, oil, ice, mud and other slipping hazards.
- Ensure the drill platform flooring is stable and free of debris, oil and mud, etc.
- In winter, do not allow ice to build up on drill platforms or drill equipment.
- Keep ladders free of mud, ice, etc. Use ladders only for their designated purpose. Secure them carefully and keep the area clear around the base (and top) of the ladder. When moving ladders, especially aluminum ladders, beware of overhead electrical wires and never allow them to touch exposed electrical conductors.
- Keep work areas and passageways well lit, especially at night.
- Cordon off any unsafe working areas.
- Keep the drill mast free of loose objects at all times.
- Roll up hoses and extension cords after use.
- Regularly dispose of rubbish in designated containers according to camp guidelines.
- Wherever possible, channel any fluid discharge away from the drill hole to a sump. Clean channels often so they do not get blocked by cuttings, and do not allow sumps to overflow.
- ❖ Minimize the spillage of drilling muds onto the ground as they are very slippery. Even a minor mud spill immediately becomes a slipping hazard.
- When pumping out core from triple-tubes, catch the drilling mud in a container or channel it away to a sump.
- ❖ Good housekeeping is mandatory wherever core saws are used, as water-laden dust that covers the floor, clothing and machinery will dry out allowing the dust to become airborne and respirable.
- Immediately clean up any leaks and spills according to government regulations and Diamonds North Environmental Guidelines. Have an appropriate spill containment kit on-site.

### 15.4.4 Manual Handling

**NOTE:** At drill sites, most drill crew injuries occur while handling drill rods or using tools. For drill site geologists, most manual handling injuries occur while handling bagged samples or heavy core trays.

#### **To avoid manual handling accidents:**

- Plan the drill site layout so storage plans facilitate both manual handling and the movement of personnel around the site.
- ❖ **Follow correct lifting procedures** and do not perform manual handling tasks when fatigued.

- ❖ **Be alert for slipping or tripping hazards.**
- ❖ Two persons are required for lifting and stacking full core trays.
- Ensure the contractor stacks and secures all rods, casings and drilling stores, etc., so they cannot roll or be knocked down.
- Use gloves for handling wire rope, drill rods, core trays and any sharp, hot or slippery objects.
- Ensure the contractor adopts rod handling procedures/systems that eliminate the need for crew to lift heavy weights, or to jump off elevated platforms and run with drill rods.
- Only use tools that are designed for the job, and never use defective or worn tools.

## 15.5 COMMON TYPES OF DRILLING INJURIES

- **Entanglement.** Loose clothing (e.g., shirttails, jacket drawstrings, boot laces), long hair and jewelry can easily catch on rotating machine parts. These include rotating drill rods, smooth shafts, spindles and recesses or projections on shafts such as couplings, protruding set screws, keys and keyways, etc. If part of you or your clothing is caught, you may be pulled or drawn into the machinery and severely injured or killed.
- **Crush Injuries.** It is easy to crush a finger, hand, arm or foot, etc., where two machine parts close together (“pinch points” or “nip points”) or where one machine part moves against another (e.g., drill rods).
- **Entrapment.** Part of your body or clothing may catch between "drawing-in" hazards, (e.g., drivebelts and pulleys, pull-down chains and sprockets, wire ropes and sheaves).
- **Impact.** You may strike or be struck by an object as a result of a slip, trip or fall, or by thrashing high pressure air hoses, ejected machinery parts, falling objects, or the uncontrolled movement of drill rods, etc.
- **Burns.** Burns may result from contact with hot engine parts (e.g., manifolds, exhaust pipes and mufflers) or if a hose fails and sprays hot hydraulic or compressor oil into the work area. Burns may also result from contact with oil stoves used for heating the shack or with heaters for brine solution.
- **Dust and Noise.** Effects of dust and noise are cumulative and result in disabilities that are preventable. **Dust** – excessive inhalation of dust (especially asbestos, coal dust and silica) can produce fatal lung diseases. **Noise** – excessive noise produces deafness. Use the correct PPE.
- **Slips trips and falls.** The drilling platform, ladders and access areas can become slippery due to grease, fluids and/or ice buildup or other hazards during the drilling process.
- Of the drilling methods that use air pressure as a circulation method, reverse circulation drilling (RC) has higher risks than rotary air blast (RAB), air core or percussion drilling due to the use of elevated air pressures, heavier drill rods and more powerful machinery.

## 15.6 HAZARDS LINKED WITH SPECIFIC EQUIPMENT

Drill site employees must be fully informed and understand the different safety hazards related to specific drilling methods and sampling procedures.

### 15.6.1 Pressure Hazards

Because of the complexity of compressed air systems, Adamera relies heavily on the standard of the contractor's maintenance and inspection procedures to manage the hazards and risks of compressed air systems.

- ❖ Stay away from the “**Danger Zones**” of the drill site. Adopt the “**Keep Clear Principle**” around all compressors and high pressure air hoses.

#### 15.6.1.1 Compressed Air Systems

Compressed air is used as the circulation medium for RC, RAB, Air Core and Rotary Percussion drilling. High pressure hoses can break away with explosive force and thrash about violently. A sample discharge hose that fails may eject drill chips as it whips about. A hose or hose coupling failure may result in serious injury or death.

- ❖ **Understand the destructive capability of breakaway high pressure air line hoses.**
- ❖ **Always ensure that whipchecks are attached to each end of high pressure hoses.** Stocking type whipchecks are recommended because they provide the best protection against the dangers of a whipping hose (see Figure 1). Two (2) stocking type whipchecks – one at each end of the hose are recommended for restraining high pressure air hoses. Contractors must carry out regular safety checks on all air hoses, sample hoses, hose couplings and hose restraining devices (whipchecks).

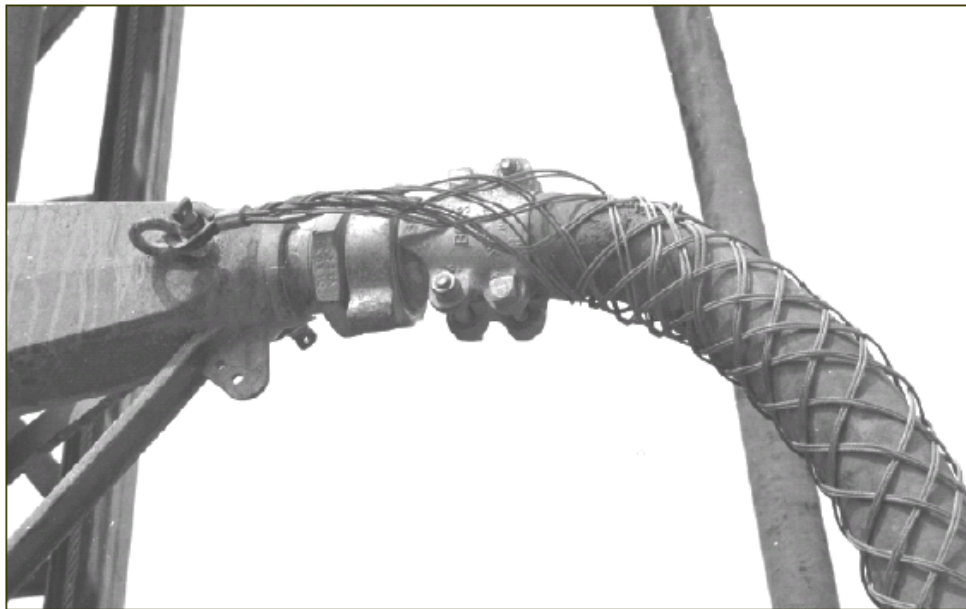

**Figure 1. Cable Stocking whipchecks are recommended on both ends of high pressure air line hoses.**

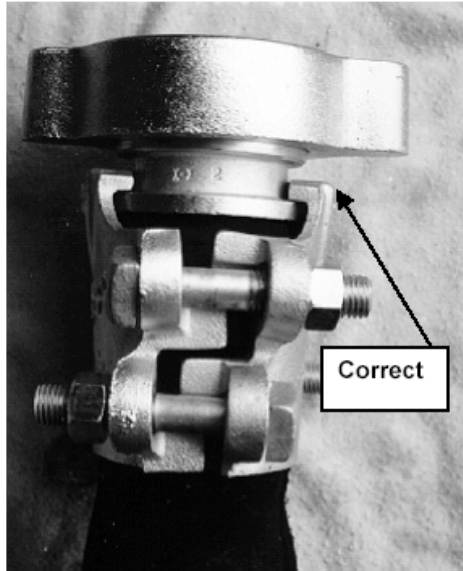

Figure 2. Safely fitted hose couplings. Hose clamps lock into the stem groove.

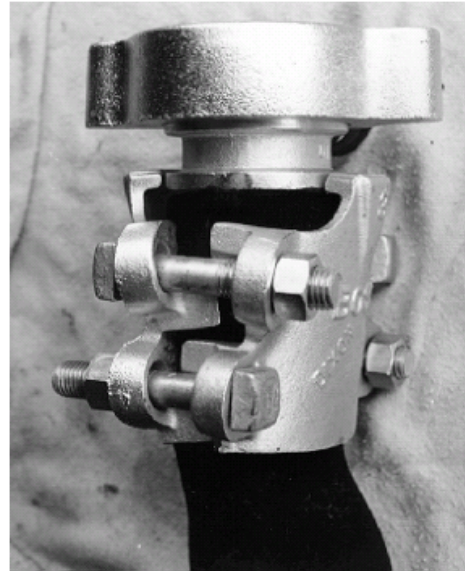

Figure 3. Unsafe hose couplings. Hose clamps do not lock into the stem groove.

**Adamera personnel must be able to identify incorrectly fitted hose couplings**, i.e., hose clamp lugs **must** lock into the stem groove as shown in Figure 2. The coupling assembly must not contain any mismatched parts as shown in Figure 3.

- ❖ When approaching an RC drill, do so away from the collar blow-out pipe to avoid being hit by flying rocks or foam. Normally, a 6-metre long PVC pipe or hose is used to divert this discharge away from traffic areas, people and machinery. Where circumstances do not permit this, place hazard flagging, cones or signs around the danger area.
- ❖ You may be injured by compressor discharge air or by surface dust or gravel blown from the ground by compressor discharge air. **Drillers discharge compressed air intermittently and whenever a compressor shuts down**; unless you are the driller, you won't know when this may occur. **Keep clear of compressors.** All air compressors must be equipped with a fully operational pressure relief valve.
- Never direct compressed air toward the body. If air is forced through the skin, air bubbles may enter the blood, which can be life-threatening. Compressed air may penetrate the skin even through clothing.
- There is potential for any pressurized hose to fail if its external surface is deformed, cut or damaged. Even a minor cut may lead to rust and corrosion of the internal wire braiding. Do not drive over pressurized hoses.
- Adamera prohibits the use of compressed air to pump core from a triple-tube core barrel.

### 15.6.1.2 Hydraulic Systems

Nearly all drills incorporate some form of hydraulic system. Hoses may leak hydraulic fluids causing fire or environmental damage. To reduce risks, contractors must ensure that hydraulic pressures do not exceed the manufacturer's recommendation, inspect hoses frequently and replace damaged hoses immediately.

- ❖ **Loads.** Never stand under any object that is being lifted or held up solely by hydraulic cylinders (rams). Once drill masts are raised by hydraulic rams, they need support by braces, stays or mast locking pins, as this provides a backup in the event of a hydraulic failure.
- **Pinhole leaks.** Never try to find a leak in a hydraulic hose with your hands. Use a piece of cardboard. The escape velocity of hydraulic oil from a pinhole leak can penetrate the skin and enter the blood stream and cause serious infection.
- **Heat.** As hydraulic systems generate considerable heat, a burst hose can spray hot oil and cause severe burns.
- **Hose and Coupling Failure.** To help prevent failure, ensure that hydraulic hoses and couplings are correctly installed. Hoses subject to internal blockages may fail. Preventative actions include:
  1. Hoses should have no twists, kinks or bends.
  2. Each hose must be the correct length – long enough to flex, but not too long.
  3. Hoses must not be under tension.
  4. Hoses must not rub or abrade against other objects.
  5. **Hoses and couplings must match and lock completely and correctly** (Fig. 2).

### 15.6.1.3 High Pressure Pumping Systems

Apply the “**Keep Clear Principle**” to high pressure mud and water pumps.

- ❖ **Pressure Relief (PR) Valves.** High pressure pumps, especially the triplex circulation pump, may explode if they lack a functioning pressure relief (PR) valve. There is potential for serious injury. At the start of all drilling programs, ask the driller to demonstrate that all pump PR valves actually open at the preset relief pressure under operating conditions.
- ❖ **Failure of hose coupling at the water swivel.** On older style or hydrostatic diamond drills, restraining cables or safety chains are mandatory for the hose/water swivel connections at the top of the drill stem to restrain the hose in case the coupling or the hose fails.

### 15.6.2 Mechanical Hazards

- ❖ **NEVER WEAR** loose, unbuttoned, torn or ragged clothing, loose gloves with wide cuffs, jackets with drawstrings lacings or straps, loose boot-laces, unrestrained long hair, necklaces, rings or other jewelry. It is very easy for clothing or these items to suddenly become entangled in rotating drill rods, augers or unguarded moving machinery parts.



## Drill Danger Zones

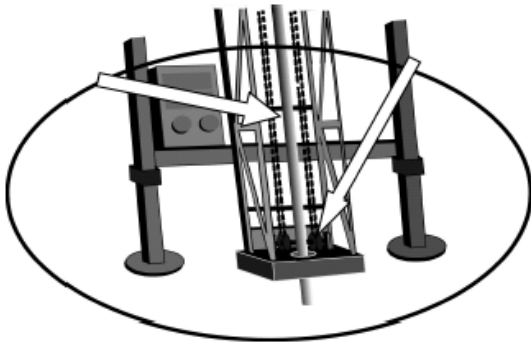

Figure 4. DANGER ZONE –  
Unguarded Drill Rods, Pulldown Chains  
and Sprockets, or Cables and Sheaves

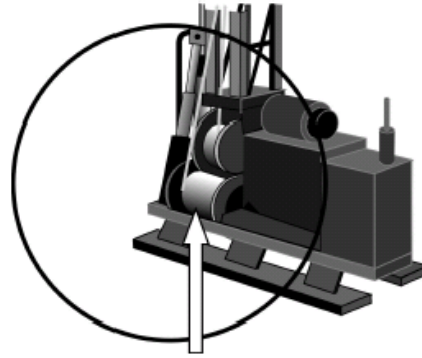

Figure 5. DANGER ZONE –  
Unguarded Winch Drums

### 15.6.2.1 Rotating Drill Rods

Serious injuries, even death, can occur when workers become entangled in rotating drill rods and augers. Although some guards exist, the effective guarding of rotating drill rods is difficult to achieve.

- ❖ The immediate area around rotating drill rods or augers is a “**Danger Zone**”, regardless of the drilling method (see Figure 4). Additional hazards (“drawing in”/ entanglement) within this danger zone include unguarded pull-down sprockets or sheaves.
- ❖ Be vigilant and stand well clear of drilling machinery, especially during hoisting, handling or changing of drill rods. Rods sometimes fall from the mast.

### 15.6.2.2 Exposed Machine Parts

- Keep clear of unguarded machine parts such as winch drums (see Figure 5).
- Ensure moving parts of machinery and hot machinery parts are guarded, if possible.
- Ensure that machine guarding does not present a hazard, i.e., loose or with sharp edges.

### 15.6.2.3 Entanglement (“Pinch Points” or “Nip Points”)

Moving machine parts present a hazard that has the potential for entanglement, entrapment or crush injuries. Most “caught between” or “drawing-in” accidents involve drill rod handling, rotating drill rods, rod wrenches, rod clamp jaws, pull-down cables and sheaves or pull-down chains and sprockets (see Figure 4).

### 15.6.2.4 Mechanical Failures

- The failure of machinery or components and tools, etc., may result in serious impact injuries and/or death. Examples include objects that fall from the mast, structural cracks in the mast that cause it to collapse, metal fatigue in tools such as stilsen wrenches (powered rod wrenches) and the ejection of failed parts such as fan blades.

- It may be difficult to detect early signs of mechanical failure. Mechanical failures are less likely to occur when drill crews are properly trained and they adhere to recommended maintenance and inspections schedules.
- ❖ Keep clear of operating drilling equipment to avoid impact injuries.

## 15.7 Hazardous Substances

### 15.7.1 Dust

- ❖ Dust may be a serious problem when working around drill rigs using compressed air circulation and when processing drill samples. *See Hazardous Substances 22.5.*
- ❖ Wear approved respiratory protection (dust masks or respirators), as required, and change the filters frequently. Ensure respirators fit correctly.

### 15.7.2 Other Hazardous Substances

- 15 Consult with the Project Manager or Drill Contractor for information about use, handling procedures, storage and the transportation of drilling additives, hazardous chemicals, fuels, pressurized gases and for information about Materials Safety Data Sheets (MSDSs).
  - Use the correct PPE as specified by Adamera, by chemical warning labels or by the MSDS.
  - Keep all MSDS sheets in an easily accessible central location (e.g., drill shack or drill truck) and in an accessible, organized manner, such as in a 3-ring binder. Workers must have quick access to MSDSs, as they contain information on first aid, PPE, etc. Keep a *copy* of the MSDS with the product.
  - ❖ **Chemical drilling fluid additives** may be used by diamond drilling contractors to alter the physical properties of drilling mud. Most of these are highly alkaline and can cause skin burns and eye injury (*see Hazardous Substances 22.5*). **Stand upwind when chemical drilling additives are being mixed to avoid breathing the dust.**
  - If possible, use less hazardous chemicals than NaOH and safer surveying methods than HF (e.g., single shot cameras, Light Log, Tropari).
  - A combination developer/fixer chemical may be used to process films from downhole survey cameras. This chemical is slightly caustic so follow the MSDS directions.
  - Two-part chemical foam mixes are widely used by RC and RAB drilling contractors to seal around the drill hole collar pipe. Follow the MSDS directions.
  - Should an accident occur involving hazardous substances, take the MSDS sheet(s) along with the victim to hospital so the medical staff will know what procedures are required for treatment. Then there will be no question about which substance(s) they must deal with and the correct treatment can begin sooner.

## 15.8 FIRE

Pay particular attention to the possibility of fire, as drill sites contain many combustible materials. If the location is dry or very cold, fire is a serious risk.

- Whenever possible, clear the drill site of combustible material such as long dry grass.
- All drill sites and camps must have the appropriate equipment and procedures to deal with local fire risks (e.g., forest fire, brush fire, grass fire). Know the location, limitations and use of fire fighting equipment (*see Camp 12.4*).

- Mount approved fire extinguishers in readily accessible places. Have at least one clearly labelled ABC type fire extinguisher 4.4 kg (10 lb) at the drill. They must also be present on all heavy equipment, all support trucks and personnel vehicles. Check extinguishers regularly and recharge them immediately after use.
- Isolate fuels, oils and gas cylinders, etc., in a cleared designated area. Pay strict attention to the safe use of flammable materials.
- Never fill fuel tanks of any machines while they are running. Allow mufflers, exhaust pipes and hot components time to cool-off before refuelling.
- Pay special attention to safe handling of wood or oil stoves, propane tiger torches and electrical wiring in drill shacks, as these items may easily start a fire.
- Follow safe smoking rules.
- Do not weld or perform maintenance using a heat source near the fuel or oil system of machinery, including compressors.
- Keep engines free of excessive dirt, grease, oil, spilled fuel and accumulated leaves, twigs or other flammable material.
- **Drill Rig Fires.** Leaking or broken fuel lines and ruptured hydraulic or compressor oil hoses may cause drill rig fires. RC type drills are at higher risk, as heat exchanger fans on some rigs may atomize hydraulic oil or fuel and cause a “fireball”. Ensure that the drill engine exhaust exits the rig or drill shack so it is not near any combustible material.
- **Core saws.** When using a core saw, wear non-flammable clothing and change your clothes if you spill fuel, oil or grease on them. Sparks generated while cutting may cause clothing to catch fire.

## 15.9 HEALTH

### 15.9.1 Noise

**Wear appropriate PPE to protect your hearing.** Make sure that earplugs and earmuffs fit correctly. The risk depends on the intensity of noise and length of exposure. While most cases of industrial deafness are due to years of exposure to high noise levels, hearing may be permanently damaged by exposure to very high noise levels for relatively short periods.

### 15.9.2 General Health Issues

- When obtaining prescription medication, check with your doctor to confirm there will be no effect on your ability to operate machinery or safely perform your duties.
- Keep the drinking water supply in a clearly marked, clean and closed container at the drill site. Drink only this water. Provide clean cups for drinking purposes. Keep
- potable water clearly separate from water that is not potable.
- Do not lick drill core samples. Chemical residues left by drilling fluids may be poisonous.

## SECTION D

### EMERGENCY PROCEDURES

In the event of an emergency situation such as fire, accident or fuel spill, the following general procedures are recommended. Specific plans related to each incident type will be reviewed in camp, with safety equipment and first aid trained personnel identified.

We support a first response system whereby the first person on the scene of an incident (if the project manager, or first aid attendant is not in the immediate area) is encouraged to take control of the situation and react appropriately to prevent further injury and/or damage.

1. Assess the situation and immediate dangers to all personnel, including proximity to fuel, propane, electrical lines, moving equipment. Determine the number of injured.
2. Yell for help.
3. Take immediate control of situation until first aid help, project manager arrives.
4. If further help is required, select someone to communicate the situation via telephone or radio. Request immediate support if evacuation or fire fighting is required and advise if serious injury is involved. Contact numbers/names should be clearly posted by the telephone or radio in camp, and in the helicopter. **If support is required, give out the posted camp coordinates and ask them to be repeated, as a check.**
5. Remove injured personnel from dangerous scene such as possible fuel/propane explosion, fire.
6. Administer first aid and make injured comfortable and/or evacuate if required and select personnel to lead the campaign to prevent further damage by extinguishing fire, containing spill etc.
7. In the event of a fuel spill or potential fuel spill, refer to the Fuel Spill Contingency Plan attached.

### **Pre-program Safety Meeting**

#### **Frequency**

- Adamera requires a pre-program safety meeting prior to commencing work on any project.
- A pre-program safety meeting is mandatory for all new personnel arriving at a work site to ensure that all new employees (or contractor) are made aware of safe operating procedures.
- Subsequent safety meetings should be held regularly, i.e., monthly, weekly or more often as conditions dictate. All Adamera employees and all contractors' employees must participate.
- The pre-program safety meeting should include all contractor and Adamera staff.
- The safety meeting must aim to reinforce the highest level of safety awareness and ensure all safe work procedures and equipment are in place to accomplish all tasks safely.

- The safety meeting should emphasize that safety is a team approach among all people on-site.
- The safety meeting should promote a positive attitude toward safety among the contractor's staff.

**Suggested topics to cover at the pre-program safety meeting include:**

- Site-specific rules and safe operating procedures
- Coordination of activities of all contractors
- Emergency Response Plan (ERP) and emergency contacts. Emergency procedures should almost always be part of the safety meeting agenda and should be thoroughly reviewed. Emergency response must be tested to see if it works. Discuss emergency procedures and make sure that everyone is familiar with them.
- Communication procedures
- Communication equipment and, if appropriate, instruction in the use of the equipment
- Responsibilities of workers, supervisors and management
- Acclimatization requirements for climatic conditions or high altitude
- First aid and medical services
- Available general site services
- Documentation required by Adamera and outside agencies
- Frequency of work site inspections
- Site security
- Wildlife concerns
- Environmental issues, e.g., site preparation, site cleanup, hazardous materials, spill containment

## SECTION E

### FIRE PROCEDURES

In Arctic winter conditions, exposure to the cold can be just as deadly as the fire itself. Everyone must prepare for the possibility of having to evacuate their quarters in the middle of the night.

You must always keep a warm coat in your room or tent and wear appropriate indoor/outdoor shoes around camp (e.g. running shoes) in case you have to leave the building and go outside immediately.

If you hear the fire alarm or three blasts of a hand held foghorn in a tent camp these procedures are to be followed:

- Treat all fire alarms as if there were an actual fire.
- In case of fire pull the nearest fire alarm or blast three sounds with a hand held foghorn in a tent camp.
- If the fire can be put out with an extinguisher, do so **AFTER** you have sounded the alarm.
- If you are awakened by the alarm, **GRAB YOUR COAT AND FOOTWEAR AND GET OUT!**
- If you are awakened by the alarm and you smell smoke, **DO NOT STANDUP!** Roll out of bed and stay as close to the floor as possible. Collect your **COAT AND FOOTWEAR QUICKLY.**
- Feel the door and if it is hot, **DO NOT OPEN THE DOOR! LEAVE THROUGH THE WINDOW IMMEDIATELY OR CUT A HOLE IN THE TENT WALL (IF HOUSED IN A TENT).**
- Everyone is to meet in the office or kitchen for a crew count. Report to your foreman at once.
- **DO NOT LEAVE THE ASSEMBLY SITE.** Your foreman or camp manager will give you further instructions.
- **UNDER NO CIRCUMSTANCES** are you to attempt retrieving personal belongings until you have authorization to return to your room or tent.

## SECTION F

### MEDICAL/MEDIVAC PROCEDURES

#### IN THE EVENT OF ANY INJURY

1. **ALERT THE FIRST AID ATTENDANT(S) OR CAMP SUPERVISOR**
  - Accident location
  - How many people are involved
  - What has happened
2. **THE FIRST AID ATTENDANT OR CAMP SUPERVISOR ON SITE TAKES CHARGE** of the situation making the decisions regarding who else needs to be contacted immediately.
3. **IF THE FIRST AID ATTENDANT OR CAMP SUPERVISOR REQUIRES YOUR ASSISTANCE YOU MAY BE ASKED TO DO THE FOLLOWING:**
  - Call Stanton hospital, ask for nurse/doctor on duty, explain situation
  - If required call Discovery Mining Services (1-867-920-4600)
  - Call Adamera office in Vancouver on the Satellite phone.
  
  - If for some reason no one can be reached call Air Tindi on the satellite phone then the rest of the information you will need is as follows:
    - i) **OUR CAMP GPS COORDINATES ARE:**  
(Information needed by airplane pilots)  
  
"CAMP": Hepburn  
  
Hepburn Camp  
Latitude: 66°20'57" N  
Longitude: 115°19'56" W
  
    - ii) They will advise **STANTON HOSPITAL (1-867-920-4111)** in Yellowknife that they will be receiving a patient and estimated time of arrival.
  - Post notices that all radio and frequencies are to be left open for calls regarding emergency **ONLY**.
4. **REPORT** to the **FIRST AID ATTENDANT** what happened during the previous calls and **STAND BY** in case of further assistance is required.
5. Contact Workers' Compensation Board if the accident is a reportable incident @ 1-800-661-0792. If a dangerous situation has occurred, WCB must be informed within 24 hours.

**SECTION G**  
**HEAD OFFICE ADDRESS**

**ADAMERA MINERALS CORP.**

Head Office: 1100 – 1111 Melville Street  
Vancouver, B.C.  
V6E 3V6

Phone: (604) 689-2010

Fax: (604) 484-7413

GIS Manager: Zoe Pratt

Email: z.pratt@adamera.com

**IMPORTANT PHONE NUMBERS**

**Expeditor – Discovery Mining Services, YK** (867) 920-4600  
**After Hours** (867) 873-1573

**RCMP Yellowknife** (867) 669-5100

**Stanton Hospital Yellowknife** (867) 920-4111

**24 Hour Spill Report Line** (867) 920-8130

**Great Slave Helicopters** (867) 669-6742

**WCB Hotline** 1-800-661-0792